

ATTACHMENT A

Bank Stabilization Methods

Attachment A - Bank Stabilization Methods

Introduction

Attachment A includes the range of methods available for conducting stream bank stabilization in the Stream Maintenance Program.

For each method, a stream flow velocity that is appropriate for that design is included. However, stream velocities will vary with the type of vegetation, the maturity of the vegetation, and the channel type. Bank stabilization projects in unmodified channels and modified channels with ecological value are designed in consideration of both impact avoidance and acceptable risk of flooding and damage to District facilities. The factors and rationale supporting the District's determination of "acceptable risk" will be included in the NPW.

For all methods that include a revegetation or planting component, the following planting guidelines apply:

The plant palette will be based on an evaluation of the vegetation communities up- and down- stream of the erosion site, and the local soil, moisture, and hydraulic conditions. The species' relative erosion control effectiveness will also be considered. Plants utilized in the restored project area will consist of native herbaceous, shrub and/or tree species, or a mixture of these species selected from the SMP plant palette provided in Table 10-7 of the Program Manual. An as-built planting plan diagram (to scale) and plant list will be provided to the permitting agencies.

A typical planting plan is illustrated in Figure 10-10 of the Program Manual. Plantings will be installed as follows:

Herbaceous species:	4 feet average on-center
Shrub species:	8 feet average on-center
Tree species:	12 feet average on-center
Live stakes/cuttings:	2 feet average on-center

For any tree removals or other associated vegetation impacts with the project, mitigation will be accounted for separately.

Attachment A applies to on-site¹ mitigation associated with bank stabilization activities authorized under the SMP. Off-site mitigation (i.e. mitigation outside the footprint of the authorized bank stabilization structure) requires submittal of compensatory mitigation plans to the permitting agencies (see Chapter 10 and SMP2 permits). Off-site compensatory mitigation plans must be approved in writing by the agencies, and must be implemented prior to or concurrent with the bank stabilization impacts for which off-site mitigation is being provided.

For off-site mitigation sites located within the mapped SMP coverage area, the compensatory mitigation plans must include a map showing the location of the mitigation site, an SMP mitigation site identification number, a planting plan diagram (to scale), planting specifications, and the date the plantings are to be installed. For off-site mitigation sites outside of the mapped SMP coverage area, the compensatory mitigation plans must be prepared in accordance with the USACE mitigation plan requirements for general permits (33 CFR 332.4[c]) and the most current version of the USACE San Francisco District's Mitigation and Monitoring Proposal Guidelines.

¹ For the purposes of this document, on-site is within the project disturbance area. Off-site is outside of the project disturbance area.

Attachment A - Bank Stabilization Methods

#1: Earth Repair

Description:

Earth repair involves the replacement and repair of eroded channel banks using compacted soil. The eroded slope is scarified and readied for fill placement. A three-foot deep key is cut into the invert. Fill is placed and compacted 80% to 90% in 8-inch lifts. The new slope is trimmed to a 2:1 slope. The surface is seeded with fast sprouting native grass species. Geotextile/erosion control fabric is placed over hydroseeding to secure newly compacted bank, where needed per site velocity and bank slope.

The fill material needs to be appropriate to this purpose. There should be no deleterious or organic material or other debris contained in the fill. The Atterberg Plasticity Index of the material should be between 15 and 25, with the Liquid Limit no higher than 40. The material must contain at least 20% clay (by weight) passing U.S. standard sieve number 200.

Design Criteria:

Appropriate on bank slopes of 2:1 or flatter.

Appropriate for local stream velocities of 6 feet per second or less.

A typical planting plan is illustrated in Figure 10-10 of the Program Manual. Plantings will be installed as follows: Grass species utilized will be SCVWD Erosion Control Mix per Table 10-7. Seed shall be hydroseeded or hand seeded as site conditions require. An as-built planting plan diagram (to scale) and plant list will be provided to the permitting agencies.

Habitat Impact Assessment:

Channel bottom: Provides limited biotic resources

Bank: Provides limited biotic resources

Mitigation: On-site as specified in Table 10-6 and the SMP permits.

This repair method includes revegetation of the repair area using native grass and herbaceous species. This repair method will only be used on grass-lined channels where grass is the predominant vegetation, and that contain no significant (i.e. more than scattered, isolated trees and shrubs) riparian vegetation. Consequently, no additional mitigation is required. If trees and shrubs are removed as part of the bank repair they will be replaced pursuant to the requirements set forth in Chapter 10.

Attachment A – Bank Stabilization Methods
#1: Earth Repair

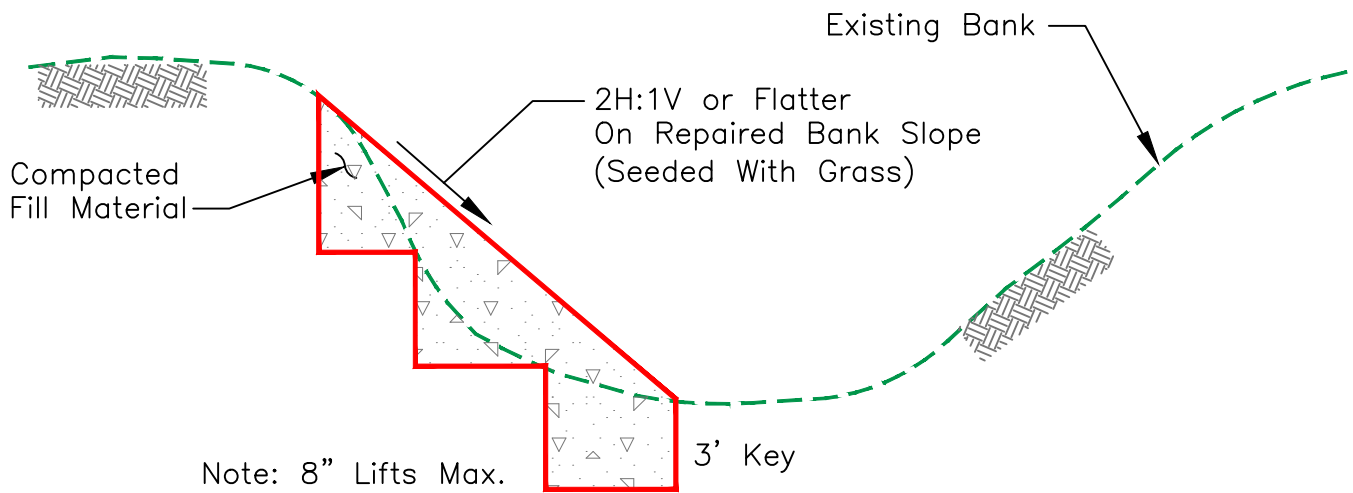

SECTION

#1: Earth Repair



Before – Quimby Creek u/s White



After – Quimby Creek u/s White

Attachment A - Bank Stabilization Methods

#1A: Earth Repair with Buried Rock

Description:

Earth repair with buried rock protects against erosion scour and stabilizes excavated or steep channel embankments. The buried rock (rock buttress) contributes to slope stability and prevents embankment failure (e.g., slumps, slides, sags). The rock structure will guard against bank scour, loss of adjacent property, protect infrastructure, and arrest future erosion, thereby reducing the loss of riparian vegetation during high flow events. The rock buttress is buried and compacted earth is placed over the top to provide an area for revegetation. No hardscape features are visible above-ground upon completion of this method.

The buried rock typically requires a cutoff wall to prevent undermining. The cutoff wall is an excavated trench with revetment, rock, or boulders placed inside. The rock buttress is composed of rock revetment or boulders placed and stacked in such a manner as to construct a gravity retaining wall. The buttress height is limited and may be installed on cut benches in the embankment for purposes of stability. Earth is placed in successive lifts adjacent to the base of the rock buttress and over the tops of the boulders. Once the earth has been placed, the overbuilt embankment is cut and trimmed back to match the upstream and downstream channel side slopes and toes.

Design Criteria:

Appropriate on bank slopes of 1.5:1 or flatter.

Appropriate for local stream velocities of 6 feet per second or less.

A typical planting plan is illustrated in Figure 10-10 of the Program Manual. Plantings will be installed as follows: Grass species utilized will be SCVWD Erosion Control Mix per Table 10-7. Plant palette will be based on an evaluation of vegetation communities up and down stream of the repair site. A mix of tree, shrub, and herbaceous species will be selected as appropriate from the SMP Table 10-7. An as-built planting plan diagram (to scale) and plant list will be provided to the permitting agencies.

Herbaceous species:	4 feet average on-center
Shrub species:	8 feet average on-center
Tree species:	12 feet average on-center
Live Stakes/Cuttings:	2 feet average on-center or as rock placement allows

Habitat Impact Assessment:

Channel bottom:	Enhances biotic resources
Bank:	Enhances biotic resources

Mitigation: On-site as specified in Table 10-6 and the SMP permits. This repair method includes revegetation of buried revetment. The revegetation effort will be monitored and tracked as set forth in the Manual and SMP permits until the established success criteria are met.

Attachment A – Bank Stabilization Methods

#1A: Earth Repair with Buried Rock

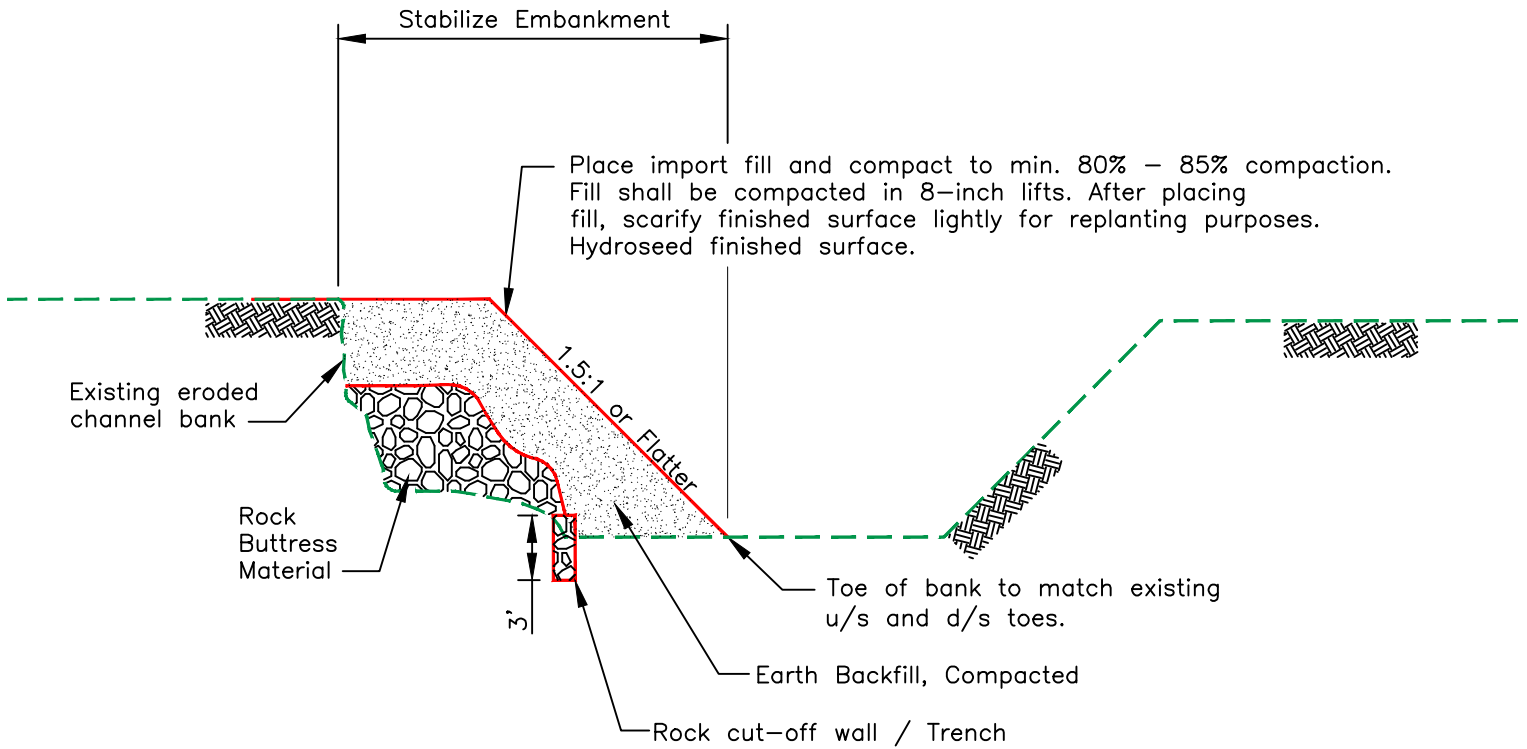

SECTION

Attachment A - Bank Stabilization Methods

#1B: Earth Repair with Boulder Base

Description:

Earth repair with rock base is used to protect against erosion scour and stabilizes steep embankments. This method is typically applied to small "flashy" channels in order to stabilize and prevent embankment failure. Due to the high erosive stresses on the channel embankments during storm events, the rock base will be sized appropriately to the localized hydraulic conditions to protect against bank scour, and loss of embankment material above the rock base. Compacted earth (80% to 90% relative compaction) is placed over the rock base to provide a uniform slope transition from the rock base to the top of bank.

The final earth repair slope will be consistent with the design criteria. At the upstream and downstream limits of the restored creek bank, the transition zones will provide a bank slope similar to the adjacent channel conditions. Erosion control for the new earth slope will include the installation of seeding with fast sprouting native grass species, or applying geotextile/erosion control fabric over hydroseeding to secure the newly compacted bank.

Design Criteria:

Appropriate on bank slopes of 2:1 or flatter for live construction section. 1.5:1 or flatter for boulder section.

Boulders must be keyed in (minimum 3 feet deep) at the base of the bank.

Appropriate for local stream velocities of 6 feet per second or less.

A typical planting plan is illustrated in Figure 10-10 of the Program Manual. Plantings will be installed as follows: Grass species utilized will be SCVWD Erosion Control Mix per Table 10-7. Plant palette will be based on an evaluation of vegetation communities up and down stream of the repair site. A mix of tree, shrub, and herbaceous species will be selected as appropriate from the SMP Table 10-7. An as-built planting plan diagram (to scale) and plant list will be provided to the permitting agencies.

Herbaceous species:	4 feet average on-center
Shrub species:	8 feet average on-center
Tree species:	12 feet average on-center
Live Stakes/Cuttings:	2 feet average on-center or as rock placement allows

Habitat Impact Assessment:

Channel bottom:	Enhances biotic resources
Bank:	Enhances biotic resources

Mitigation: On-site/off-site as specified in Table 10-6 and the SMP permits. The revegetation effort will be monitored and tracked as set forth in the Manual and SMP permits until the established success criteria are met.

Attachment A – Bank Stabilization Methods

#1B: Earth Repair With Boulder Base

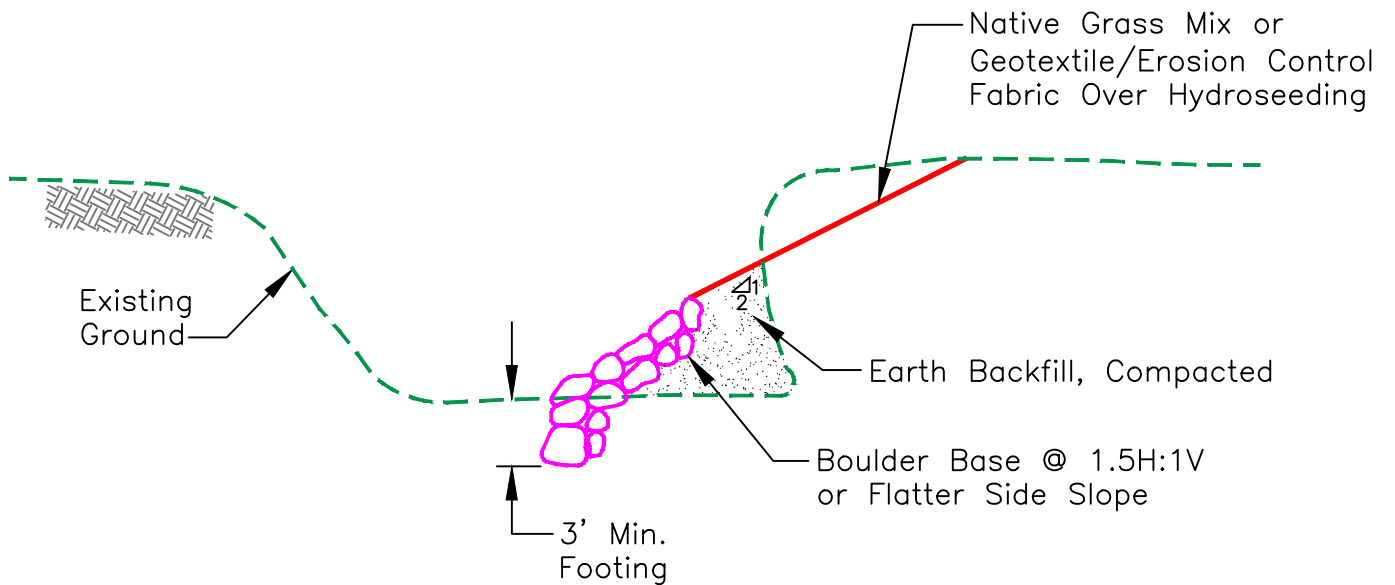
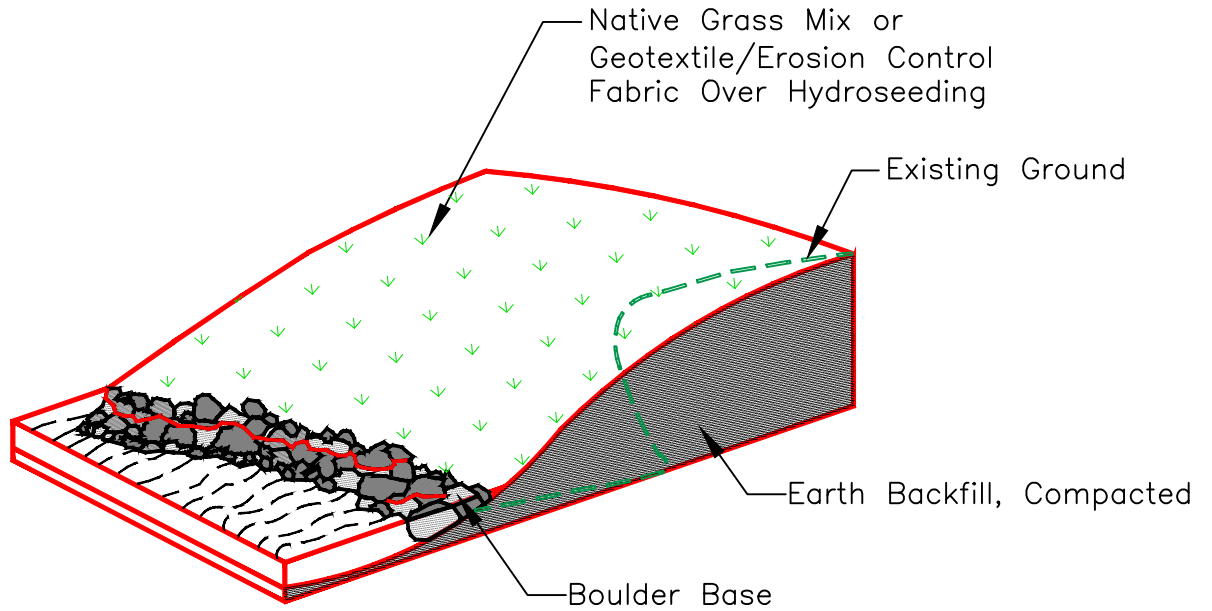

SECTION

#1B: Earth Repair with Boulder Base



Before – Canos Creek u/s Hillsdale



After – Canos Creek u/s Hillsdale

Attachment A - Bank Stabilization Methods

#2: Live Construction

Description:

Live construction consists of traditional methods of grading slopes and planting live grasses and other plants to control erosion and to restore habitat. Vegetation planting methods commonly used include cuttings, transplants, live staking, and direct seeding (including hydro-seeding). Biodegradable erosion control materials will be used where necessary in conjunction with live construction to assist in plant establishment.

Excellent revegetation potential. Most successful in stream banks where moderate erosion and channel migration are anticipated. Bank slope, eroding velocity, and reinforcement at the toe of the bank are limiting factors. Enhances conditions for colonization of native species. Stream bank soil materials, probable groundwater fluctuation, and bank loading conditions are factors for determining appropriate design.

Design Criteria:

Appropriate on bank slopes of 2:1 or flatter.

Appropriate for local stream velocities of 6 feet per second or less.

A typical planting plan is illustrated in Figure 10-10 of the Program Manual. Plantings will be installed as follows: Grass species utilized will be SCVWD Erosion Control Mix per Table 10-7. Plant palette will be based on an evaluation of vegetation communities up and down stream of the repair site. A mix of tree, shrub, and herbaceous species will be selected as appropriate from the SMP Table 10-7. An as-built planting plan diagram (to scale) and plant list will be provided to the permitting agencies.

Herbaceous species:	4 feet average on-center
Shrub species:	8 feet average on-center
Tree species:	12 feet average on-center
Live Stakes/Cuttings:	2 feet average on-center or as rock placement allows

Habitat Impact Assessment:

Channel bottom:	Enhances biotic resources
Bank:	Enhances biotic resources

Mitigation: On-site as specified in Table 10-6 and the SMP permits. The revegetation effort will be monitored and tracked as set forth in the Manual and SMP permits until the established success criteria are met.

Source: Adapted from Natural Resources Conservation Service. Stream Corridor Restoration Principles, Processes and Practices

Attachment A – Bank Stabilization Methods
#2: Live Construction

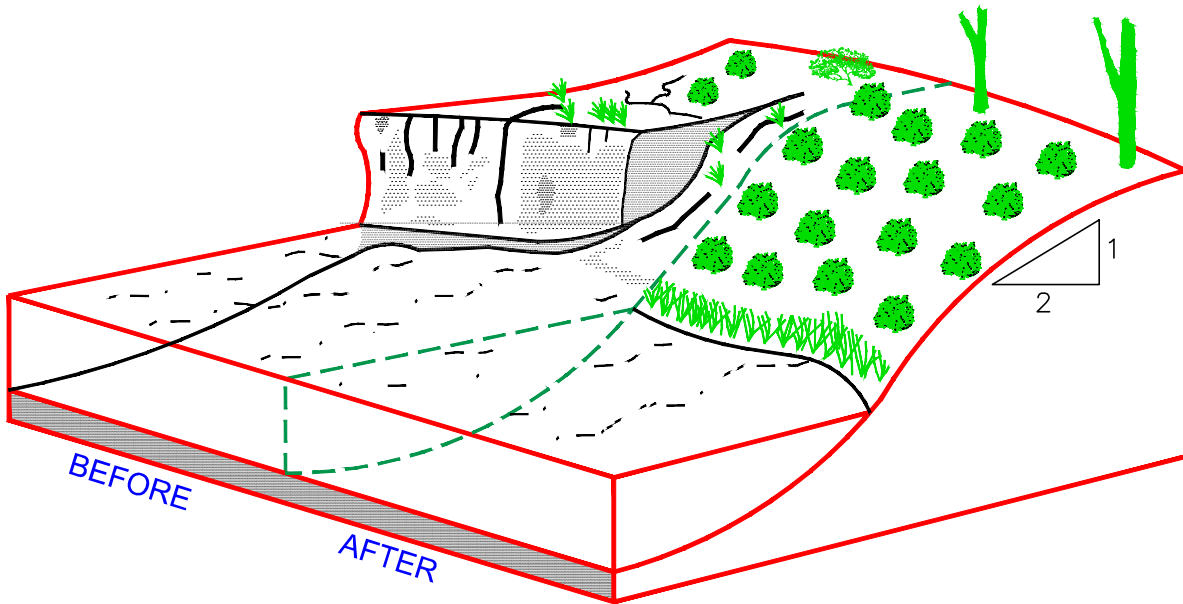

Source: Adapted from Natural Resources Conservation Service, Stream Corridor Restoration Principles, Processes and Practices

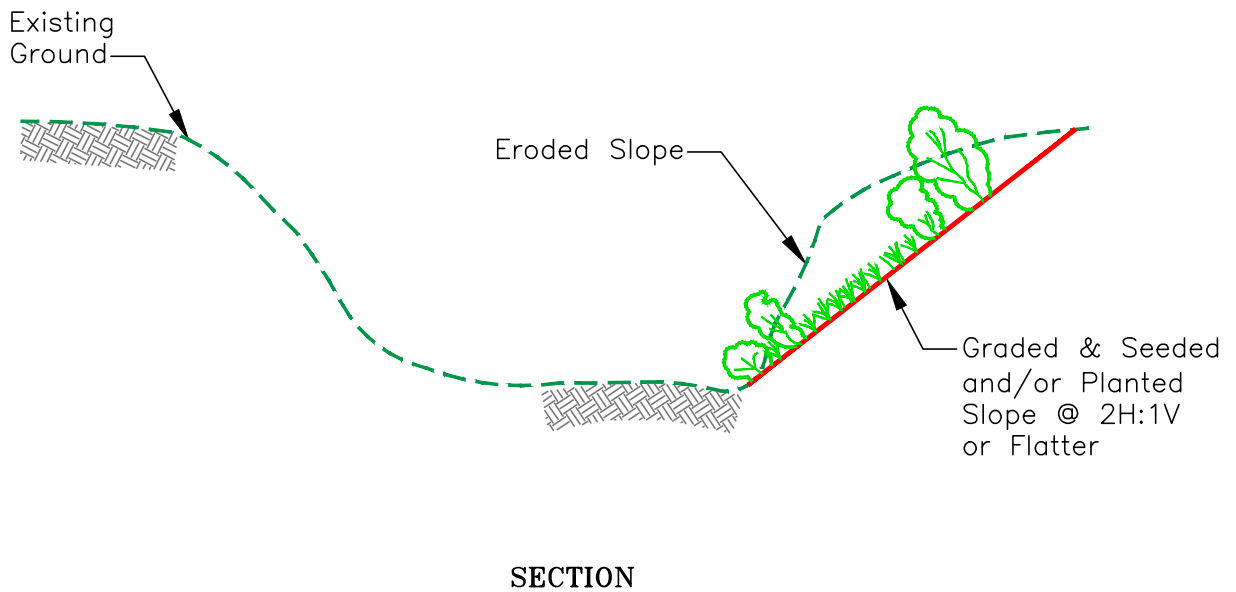

Attachment A - Bank Stabilization Methods

#2A: Live Construction with Boulder Base

Description:

Live construction consists of traditional methods of grading a flatter slope and planting live grasses and other plants to control erosion. Vegetation planting methods commonly used include cuttings, transplants, live staking, and direct seeding (including hydro-seeding). Biodegradable erosion control materials are used where necessary in conjunction with live construction to assist in plant establishment.

Appropriately-sized boulders are placed along the base of the rebuilt bank up to the elevation indicated by the hydraulic analysis and ecological site conditions. Voids in between the boulders can be planted using live stakes.

Excellent revegetation potential. Enhances conditions for colonization of native species. Streambank soil materials, probable groundwater fluctuation, and bank loading conditions are factors for determining appropriate design.

Design Criteria:

Appropriate on bank slopes of 2:1 or flatter for live construction section. 1.5:1 or flatter for boulder section.

Boulders must be keyed in (minimum 3 feet deep) at the base of the bank.

Appropriate for local stream velocities of 6 feet per second or less.

A typical planting plan is illustrated in Figure 10-10 of the Program Manual. Plantings will be installed as follows: Plant palette will be based on an evaluation of vegetation communities up and down stream of the repair site. A mix of tree, shrub, and herbaceous species will be selected as appropriate from the SMP Table 10-7. Grass species utilized will be SCVWD Erosion Control Mix per Table 10-7. An as-built planting plan diagram (to scale) and plant list will be provided to the permitting agencies.

Herbaceous species:	4 feet average on-center
Shrub species:	8 feet average on-center
Tree species:	12 feet average on-center
Live Stakes/Cuttings:	2 feet average on-center or as rock placement allows

Habitat Impact Assessment:

Channel bottom:	Enhances biotic resources
Bank:	Enhances biotic resources

Mitigation: On-site/off-site as specified in Table 10-6 and the SMP permits. The revegetation effort will be monitored and tracked as set forth in the Manual and SMP permits until the established success criteria are met.

Source: Adapted from Natural Resources Conservation Service. Stream Corridor Restoration Principles, Processes and Practices

Attachment A – Bank Stabilization Methods
 #2A: Live Construction with Boulder Base

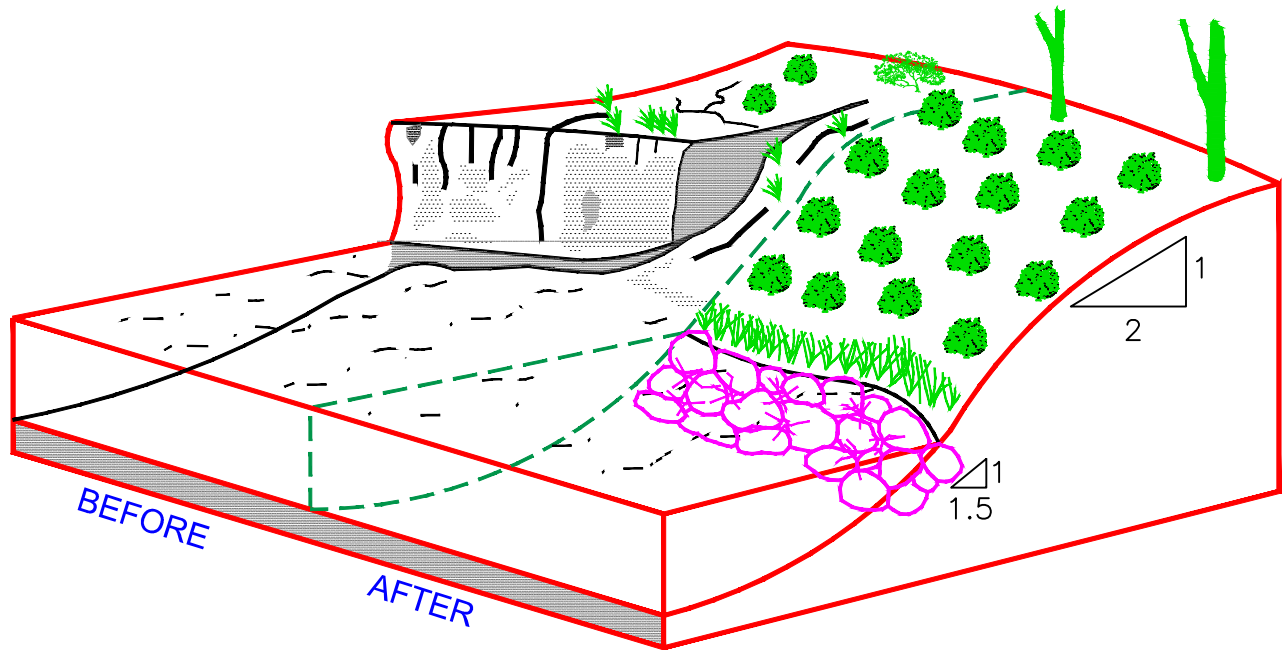

Source: Adapted from Natural Resources Conservation Service, Stream Corridor Restoration Principles, Processes and Practices

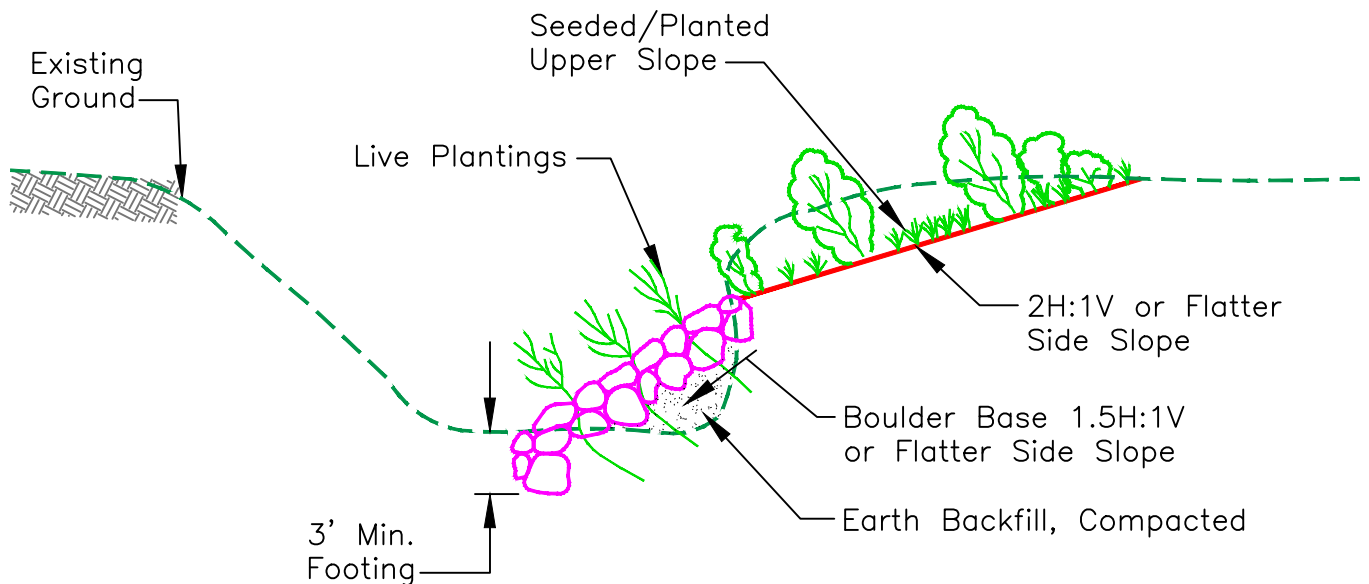

SECTION

#2A: Live Construction with Boulder Base



Before – Canos Creek u/s Hillsdale



After – Canos Creek u/s Hillsdale

Attachment A - Bank Stabilization Methods

#2B: Live Construction with Log Base

Description:

Live construction consists of traditional methods of grading a flatter slope and planting native vegetation to control erosion. Biodegradable erosion control materials are used where necessary in conjunction with live construction to assist in plant establishment¹.

Logs are anchored to the bed and/or native bank up to ordinary high water mark or the elevation indicated by the hydraulic analysis. Determine scour depth, log size (typically between 6 inches to 24 inches in diameter), and anchor system based on specific site conditions. Root wads may also be used where applicable and/or available.

This repair method is used to protect the toe line from erosion. It is especially useful for long straight channel reaches. The logs provide immediate protection from erosion while live branch cuttings contribute long-term durability and ultimately replace the decaying logs².

Design Criteria:

Appropriate on bank slopes of 2:1 or flatter for live construction section. 1.5:1 or flatter for the log base section.

Install the log base with anchors.

Appropriate for local stream velocities of 15 feet per second or less.

A typical planting plan is illustrated in Figure 10-9 of the Program Manual. Plantings will be installed as follows: Plant palette will be based on an evaluation of vegetation communities up and down stream of the repair site. A mix of tree, shrub, and herbaceous species will be selected as appropriate from the SMP Table 10-8. Grass species utilized will be SCVWD Erosion Control Mix per Table 10-8. An as-built planting plan diagram (to scale) and plant list will be provided to the permitting agencies.

Herbaceous species:	4 feet average on-center
Shrub species:	8 feet average on-center
Tree species:	12 feet average on-center
Live Stakes/Cuttings:	2 feet average on-center or as log placement allows

Habitat Impact Assessment:

Channel bottom:	Enhances biotic resources
Bank:	Enhances biotic resources

Mitigation: On-site as specified in Table 10-6 and the SMP permits. Installation of the logs is self-mitigating. The revegetation effort will be monitored and tracked as set forth in the Manual and SMP permits until the established success criteria are met.

¹Source: Adapted from Natural Resources Conservation Service. Stream Corridor Restoration Principles, Processes and Practices

²Source: Santa Clara Valley Water District, "Design Manual Open Channel Hydraulics and Sediment Transport". July 2009

Attachment A – Bank Stabilization Methods

#2B: Live Construction with Log Base

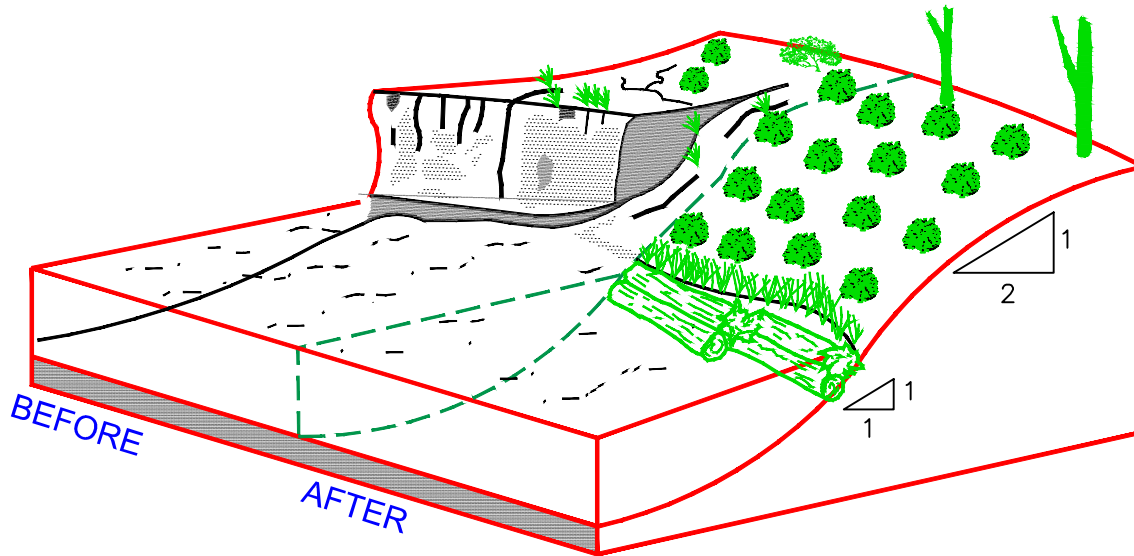

Source: Adapted from Natural Resources Conservation Service, Stream Corridor Restoration Principles, Processes and Practices

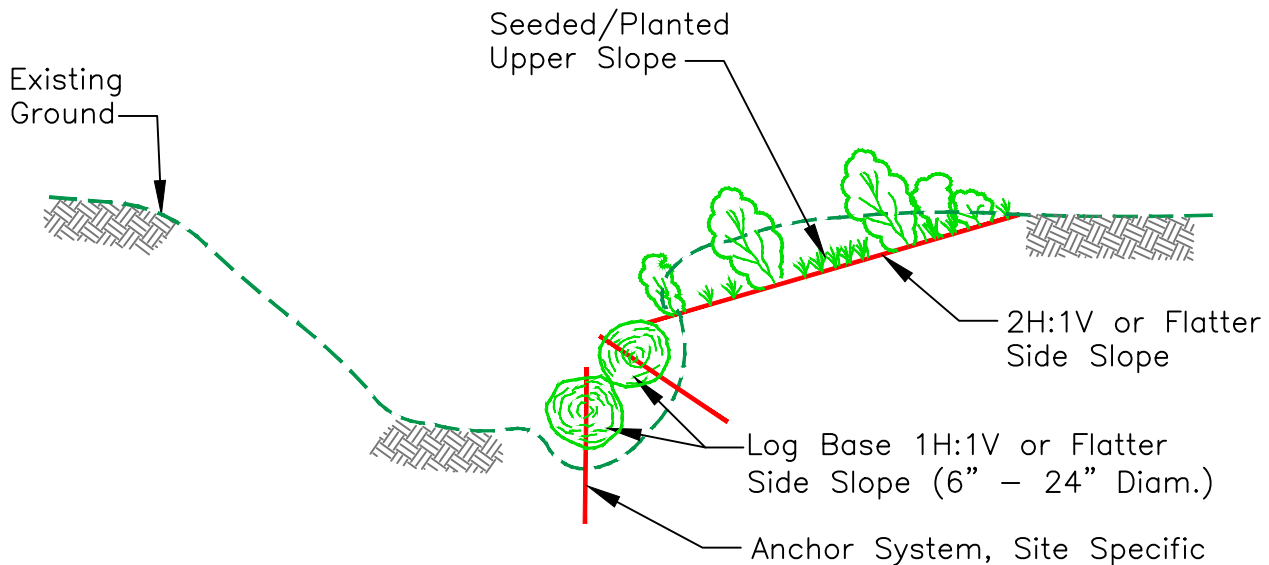

SECTION

Source: Adapted from Santa Clara Valley Water District; "Design Manual Open Channel Hydraulics and Sediment Transport", July 2009

Attachment A - Bank Stabilization Methods

#3: Contour Wattling

Description:

This method consists of tying long bundles of plant stems (typically willows or cottonwoods) together with twine and anchoring them in shallow trenches with wooden stakes or cuttings. When the stems develop root systems and mature, the plants establish structural soil stabilization properties. This technique is generally used to manage surface erosion.

Excellent revegetation potential. The long bundles trap and hold soil on banks by creating small, dam-like structures, effectively cutting the slope length into a series of shorter slope lengths. This method enhances the conditions for colonization of native species and should, where appropriate, be used with other soil bioengineering systems and live plantings. Reinforcement at the base of the bank slope may be a limiting factor (see bank stabilization methods 3A and 3B). Not appropriate for treatment of slopes actively undergoing mass earth movement¹.

Design Criteria:

Appropriate on bank slopes of 2:1 or flatter.

Appropriate for local stream velocities of 6 feet per second or less.

A typical planting plan is illustrated in Figure 10-10 of the Program Manual. Planting shall be installed as follows: Wattle wood shall be collected and soaked at least 10 days prior to installation. Prepare trenches (1/2 depth of wattle) and install wattles in location as approved by engineer. Live stakes/cuttings may be used as wattle stakes. Firmly attach bundles with rope to stakes. Provide supplemental irrigation if needed. An as-built planting plan diagram (to scale) and plant list will be provided to the permitting agencies.

Habitat Impact Assessment:

Channel bottom: Enhances biotic resources
Bank: Enhances biotic resources

Mitigation: On-site as specified in Table 10-6 and the SMP permits. Installation of the planted contour wattles is self-mitigating. The revegetation effort will be monitored and tracked as set forth in the Manual and SMP permits until the established success criteria are met.

¹Source: Natural Resources Conservation Service. Stream Corridor Restoration Principles, Processes and Practices

Attachment A – Bank Stabilization Methods
#3: Contour Wattling

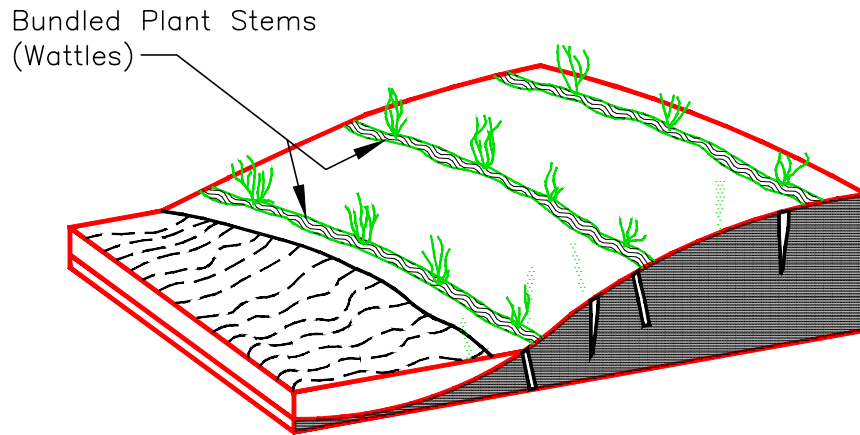

Source: Natural Resources Conservation Service, Stream Corridor Restoration Principles, Processes and Practices

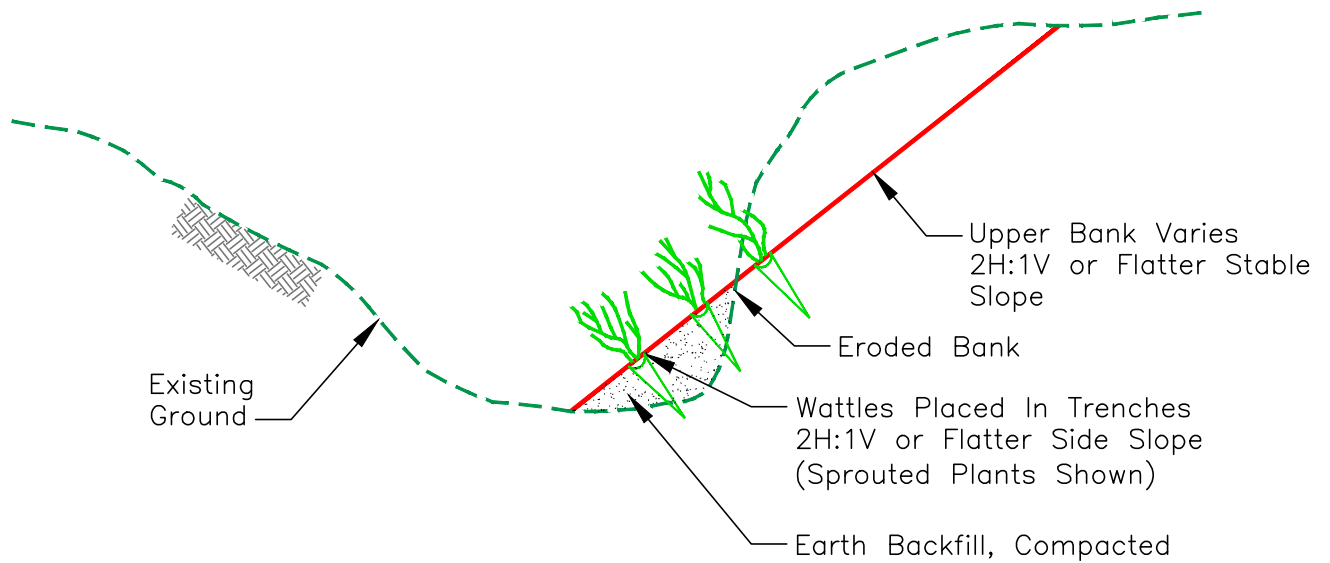

SECTION

Attachment A - Bank Stabilization Methods

#3A: Contour Wattling with Boulder Base

Description:

This method consists of tying long bundles of plant stems together with rope and anchoring them in shallow trenches with wooden stakes or cuttings. When the stems develop root-systems and mature, the plants establish structural soil stabilization properties.

Appropriately-sized boulders are placed at the base of the rebuilt bank up to the elevation indicated by the hydraulic analysis. Voids in between the boulders can be planted using live stakes.

Excellent revegetation potential. The long bundles trap and hold soil on banks by creating small, dam-like structures, effectively cutting the slope length into a series of shorter slope lengths. This method enhances the conditions for colonization by native species and should, where appropriate, be used with other soil bioengineering systems and live plantings. Not appropriate for treatment of slopes actively undergoing mass earth movement¹.

Design Criteria:

Appropriate on bank slopes of 2:1 or flatter for contour wattling section of slope, and slopes of 1:5 or flatter for boulder section.

Boulders must be keyed in (minimum 3-foot depth) at the base of the bank.

Appropriate for local stream velocities of 6 feet per second or less.

A typical planting plan is illustrated in Figure 10-9 of the Program Manual. Planting shall be installed as follows: Wattle wood shall be collected and soaked at least 10 days prior to installation. Prepare trenches (1/2 depth of wattle) and install wattles in location as approved by engineer. Live stakes/cuttings shall be used as wattle stakes. Firmly attach bundles with rope to stakes. Provide supplemental irrigation if needed. An as-built planting plan diagram (to scale) and plant list will be provided to the permitting agencies.

Habitat Impact Assessment:

Channel bottom:	Enhances biotic resources
Bank:	Enhances biotic resources

Mitigation: On-site/off-site as specified in Table 10-6 and the SMP permits. The revegetation effort will be monitored and tracked as set forth in the Manual and SMP permits until the established success criteria are met.

Source: Natural Resources Conservation Service. Stream Corridor Restoration Principles, Processes and Practices

Attachment A – Bank Stabilization Methods
#3A: Contour Wattling with Boulder Base

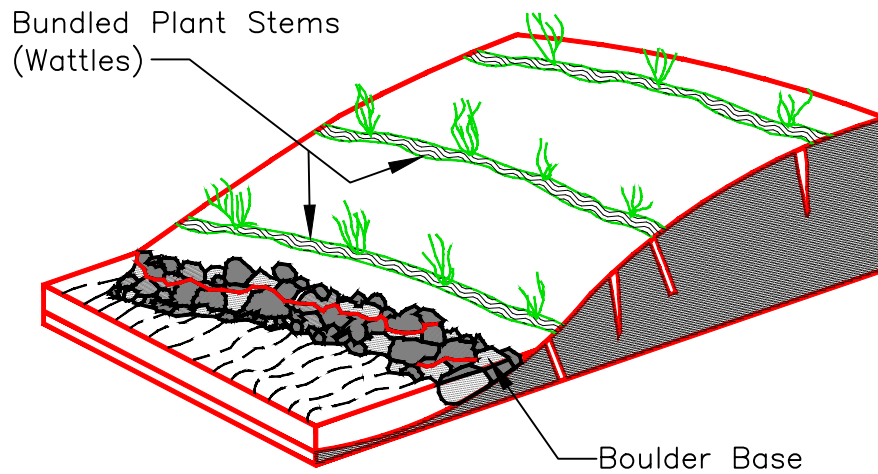

Source: Adapted from Natural Resources Conservation Service, Stream Corridor Restoration Principles, Processes and Practices

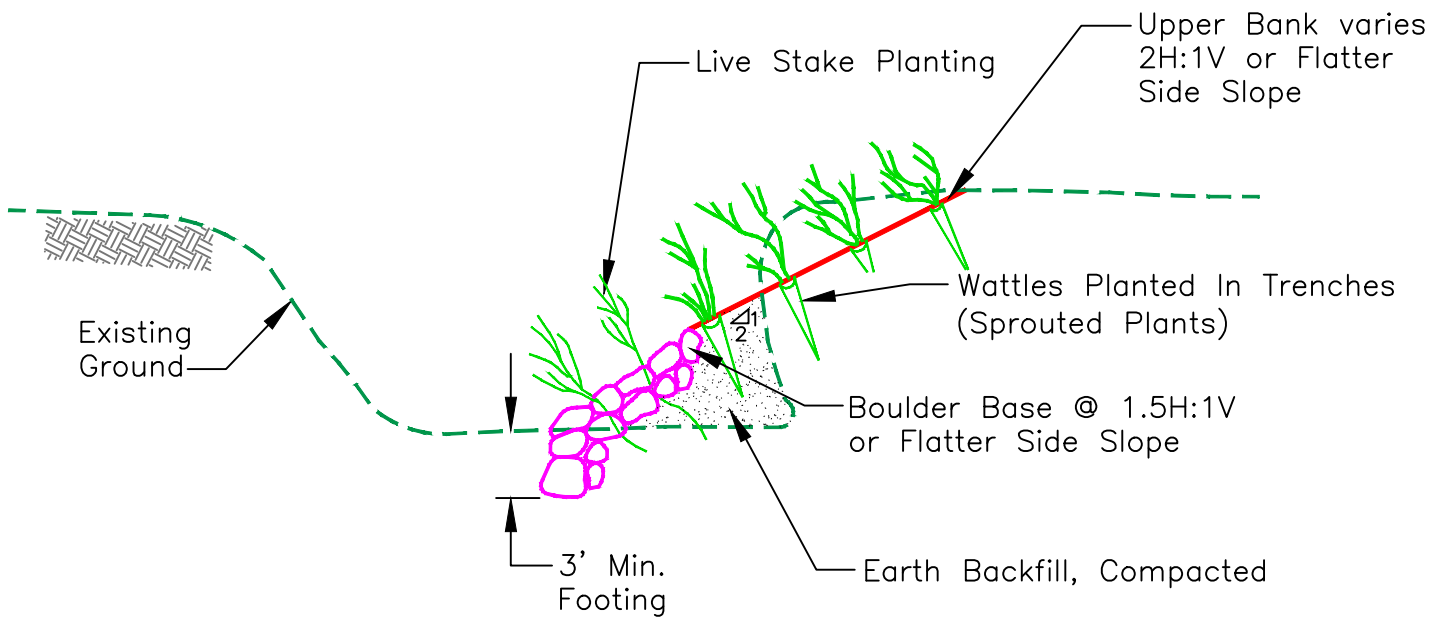

SECTION

Attachment A - Bank Stabilization Methods

#3B: Contour Wattling with Log Base

Description:

Contour wattling consists of tying bundles of plant stems together with rope and anchoring them in shallow trenches with wooden stakes or cuttings. When the stems develop root systems and mature, the plants establish structural soil stabilization properties.

Logs are anchored to the bed and/or native bank up to the elevation indicated by the hydraulic analysis. Determine scour depth, log size (typically between 6 inches to 24 inches in diameter), and anchor system based on specific site conditions. Where applicable and/or appropriate, rootwads may also be used.

This repair method is used to protect the toe line from erosion as well as manage surface erosion. It is especially useful for long straight channel reaches. The logs provide immediate protection from erosion while contour wattlings contribute to long-term durability and ultimately replace the decaying logs.

Excellent revegetation potential. The long bundles trap and hold soil on banks by creating small, dam-like structures, effectively cutting the slope length into a series of shorter slope lengths. This method enhances the conditions for colonization by native species and should, where appropriate, be used with other soil bioengineering systems and live plantings. Not appropriate for treatment of slopes actively undergoing mass earth movement¹.

Design Criteria:

Appropriate on bank slopes of 2:1 or flatter for contour wattling section of slope, and slopes of 1.5:1 or flatter for the log base section.

Install the log base with anchors.

Appropriate for local stream velocities of 15 feet per second or less.

A typical planting plan is illustrated in Figure 10-10 of the Program Manual. Planting shall be installed as follows: Wattle wood shall be collected and soaked at least 10 days prior to installation. Prepare trenches (1/2 depth of wattle) and install wattles in location as approved by engineer. Live stakes/cuttings shall be used as wattle stakes. Firmly attach bundles with rope to stakes. Provide supplemental irrigation if needed. An as-built planting plan diagram (to scale) and plant list will be provided to the permitting agencies.

Habitat Impact Assessment:

Channel bottom: Enhances biotic resources
Bank: Enhances biotic resources

Mitigation: On-site as specified in Table 10-6 and the SMP permits. The revegetation effort will be monitored and tracked as set forth in the Manual and SMP permits until the established success criteria are met.

¹Source: Adapted from Natural Resources Conservation Service. Stream Corridor Restoration Principles, Processes and Practices

Attachment A – Bank Stabilization Methods

#3B: Contour Wattling with Log Base

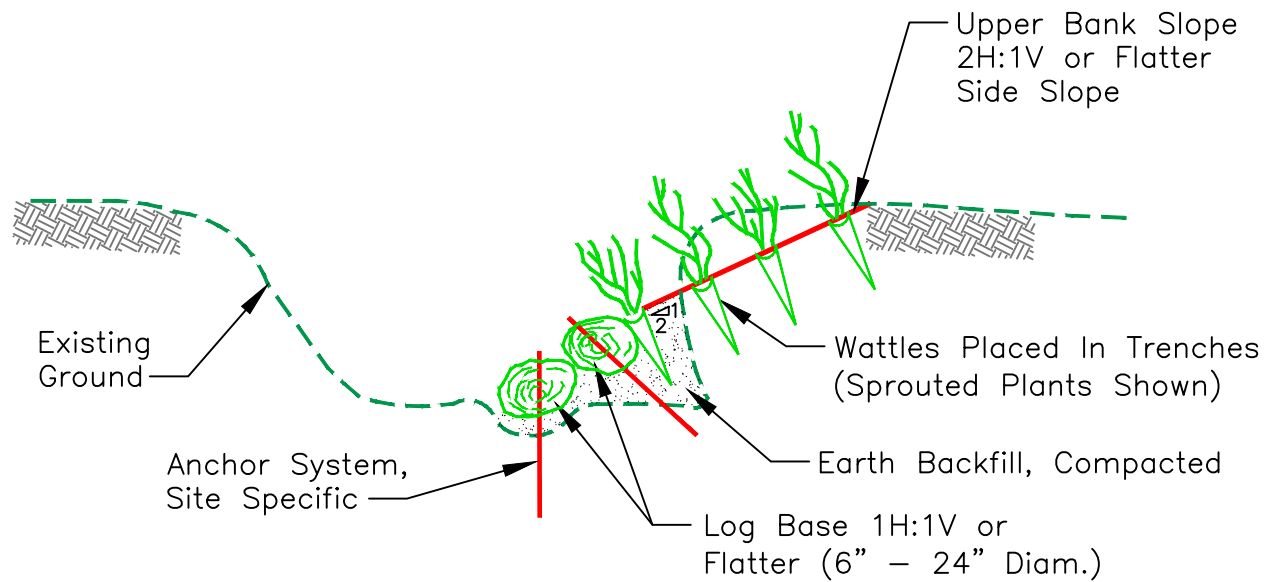
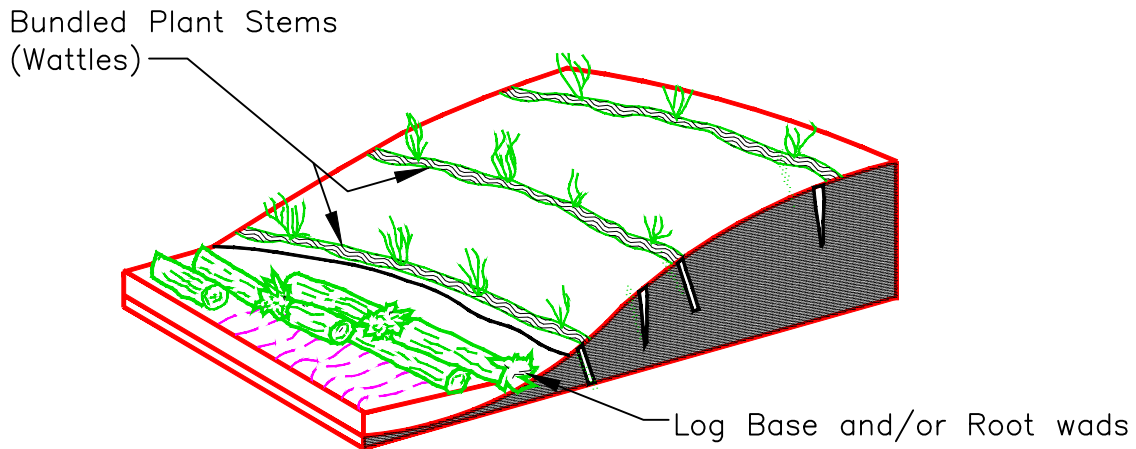

SECTION

Source: Adapted from Natural Resources Conservation Service, Stream Corridor Restoration Principles, Processes and Practices

Attachment A - Bank Stabilization Methods

#4: Brush Mattress (Brush Layering)

Description:

The eroded slope is graded and smoothed to ensure all stakes are in contact with soil. A minimum 2-foot deep trench is dug at the base of the bank for the butt ends of the branches. Wood, steel, or live stakes are partially driven in rows on three-foot centers in the area that will be covered by the mattress. After the stakes have been placed, live branches are put on the bank with their butt ends in the trench. Straight branches no shorter than 4 feet in length and ½-inch to 1-inch in diameter are used. If the branches are not long enough to reach the upper end of the mattress, several layers may be used; however, it is necessary to “shingle” the layers by lapping each new layer over the one below by at least 18 inches. Once the bank is covered by a thick layer, cross branches are placed horizontally over the bottom layer. These branches are placed against the stakes and then tied to the stakes using wire or rope. The stakes are then driven into the bank a minimum of two feet or deeper, if possible. After the completion of the mattress, the base trench is filled with appropriately sized boulders and rocks to anchor the butt ends of the branches. The entire mattress is then covered by earth or fine stream material¹.

This method forms an immediate protective cover over the stream bank, captures sediment during flood flows, and rapidly restores riparian vegetation and streamside habitat. This method is not appropriate where toe scour is anticipated (see bank stabilization methods 4A and 4B). This method should not be used on slopes that are experiencing ongoing mass movement or other slope instability².

Design Criteria

Appropriate on bank slopes of 2:1 or flatter.

Appropriate for local stream velocities of 6 feet per second or less.

A typical planting plan is illustrated in Figure 10-10 of the Program Manual. Planting shall be installed as follows. Wood for mattressing shall be collected and soaked at least 10 days prior to installation. Install in location as approved by engineer. Prepare trenches. Install butt ends so that excellent contact with moist soil is maintained. Keep moist throughout installation. Live stakes/cuttings may be used as mattress stakes. Firmly attach rope to stakes in a criss-cross fashion so that bottom layer of wood is in contact with the slope. Provide supplemental irrigation if needed. An as-built planting plan diagram (to scale) and plant list will be provided to the permitting agencies.

Habitat Impact Assessment:

Channel bottom:	Enhances biotic resources
Bank:	Enhances biotic resources

Mitigation: On-site as specified in Table 10-6 and the SMP permits. The revegetation effort will be monitored and tracked as set forth in the Manual and SMP permits until the established success criteria are met.

¹Source: California Department of Fish and Game. California Salmonid Stream Habitat Restoration Manual

²Source: Natural Resources Conservation Service. Stream Corridor Restoration Principles, Processes and Practices

Attachment A – Bank Stabilization Methods
#4: Brush Mattress (Brush Layering)

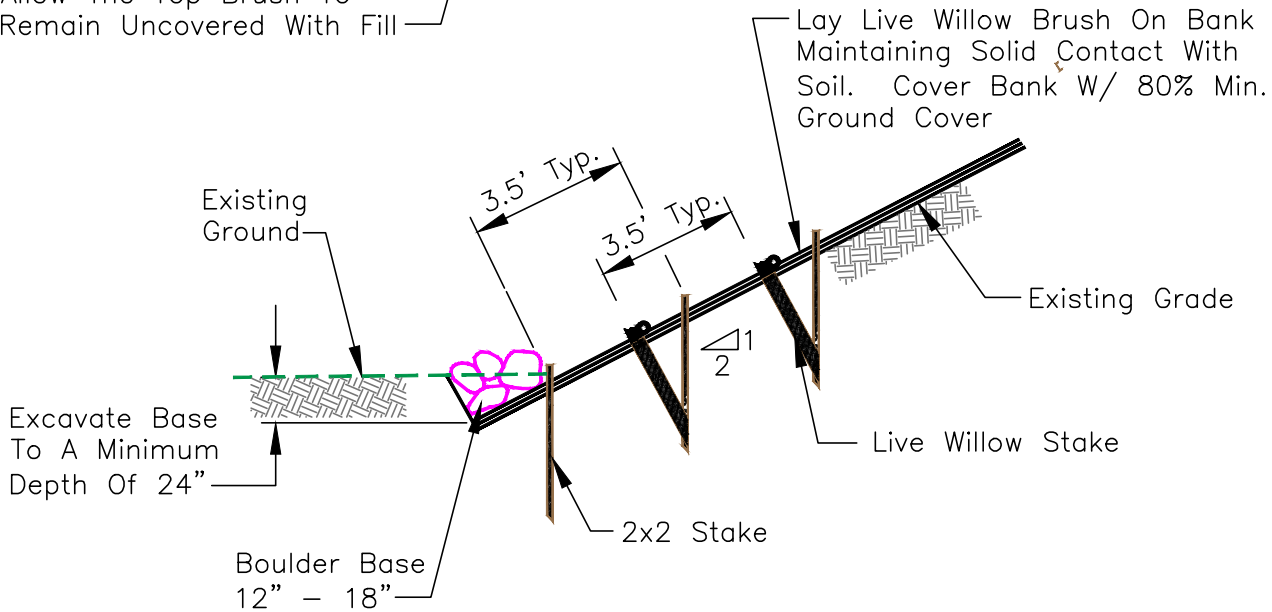
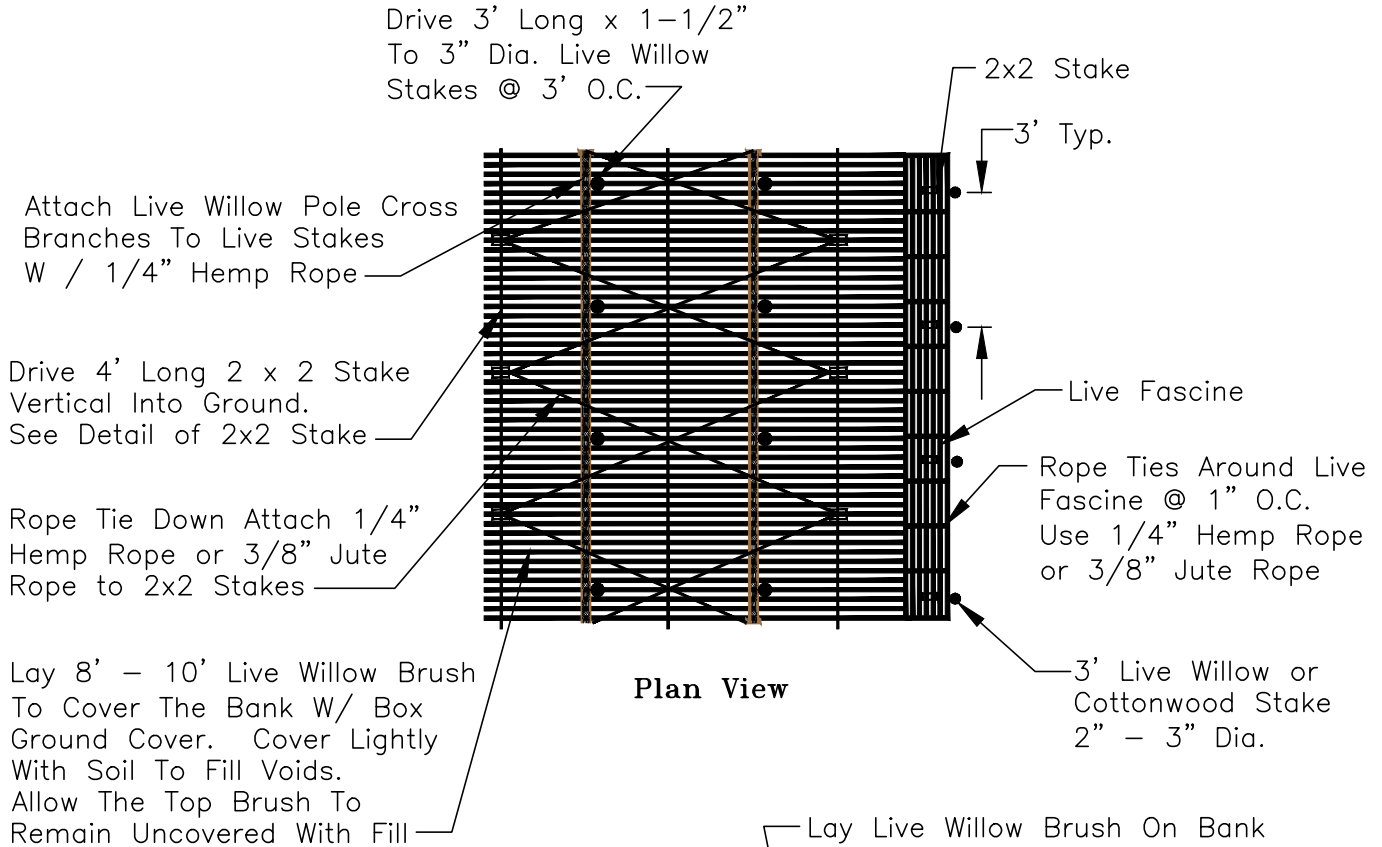

Source: Natural Resources Conservation Service, Stream Corridor Restoration Principles, Processes and Practices

Attachment A - Bank Stabilization Methods

#4A: Brush Mattress (Brush Layering) with Boulder Base

Description:

The lower portion of the eroded slope (as indicated by the hydraulic analysis) is graded at a maximum of 1.5:1 slope. The upper portion of the slope is graded at a minimum slope of 2:1 and smoothed to ensure all plantings are in contact with soil. Appropriately-sized boulders are placed at the base of the rebuilt bank up to elevation indicated by the hydraulic analysis. Voids between the boulders can be planted using live stakes.

A minimum 2-foot deep trench is dug at the top of the boulder line for the butt ends of the branches. Wood, steel, or live stakes are partially driven in rows on three foot centers in the area that will be covered by the mattress. After the stakes have been placed, live branches are put on the bank with their butt ends in the trench. Straight branches no shorter than 4 feet in length and ½-inch to 1-inch in diameter are used. If the branches are not long enough to reach the upper end of the mattress, several layers may be used; however, it is necessary to “shingle” the layers by lapping each new layer over the one below by at least 18 inches. Once the bank is covered by a thick layer of willows, cross branches are placed horizontally over the bottom layer. These branches are placed against the stakes and then tied to the stakes using wire or rope. The stakes are then driven into the bank a minimum of two feet or deeper, if possible. After the completion of the mattress, the toe trench is back filled with boulders and rocks to anchor the butt ends of the branches. The entire mattress is then covered by earth or fine stream material¹.

This method forms an immediate protective cover over the stream bank, captures sediment during flood flows, and rapidly restores riparian vegetation and streamside habitat. This method should not be used on slopes that are experiencing ongoing mass movement or other slope instability².

Design Criteria

Appropriate on bank slopes of 2:1 or flatter for brush mattress section of slope. 1.5:1 or flatter for the boulder section.

Boulders must be keyed in (minimum 3-foot depth) at the base of the bank.

Appropriate for local stream velocities of 6 feet per second or less.

A typical planting plan is illustrated in Figure 10-10 of the Program Manual. Planting shall be installed as follows: Wood for mattressing shall be collected and soaked at least 10 days prior to installation. Install in location as approved by engineer. Prepare trenches. Install butt ends so that excellent contact with moist soil is maintained. Keep moist throughout installation. Live stakes/cuttings may be used as mattress stakes. Firmly attach rope to stakes in a criss-cross fashion so that bottom layer of wood is in contact with slope. Provide supplemental irrigation if needed. An as-built planting plan diagram (to scale) and plant list will be provided to the permitting agencies.

Habitat Impact Assessment:

Channel bottom: Enhances biotic resources
Bank: Enhances biotic resources

Mitigation: On-site/off-site as specified in Table 10-6 and the SMP permits. This repair method includes revegetation of the repair area using native species. The revegetation effort will be monitored and tracked as set forth in the Manual and SMP permits until the established success criteria are met.

¹Source: Adapted from California Department of Fish and Game. California Salmonid Stream Habitat Restoration Manual

²Source: Natural Resources Conservation Service. Stream Corridor Restoration Principles, Processes and Practices

Attachment A – Bank Stabilization Methods

#4A: Brush Mattress (Brush Layering) with Boulder Base

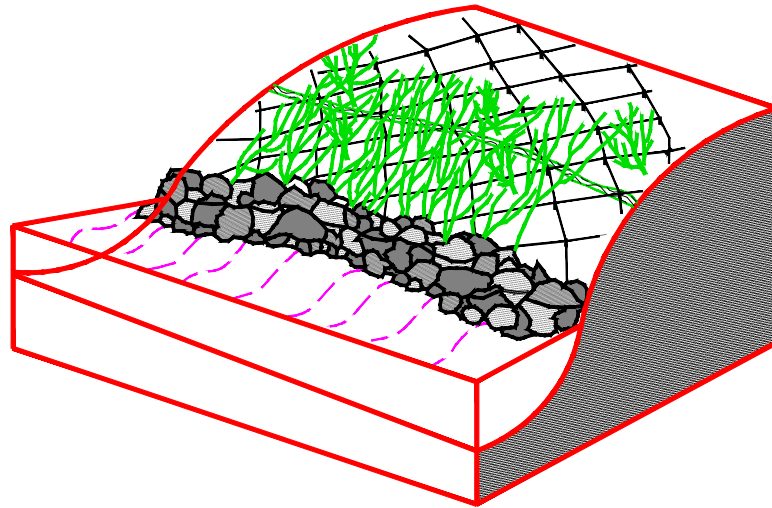

Source: Adapted from Natural Resources Conservation Service, Stream Corridor Restoration Principles, Processes and Practices

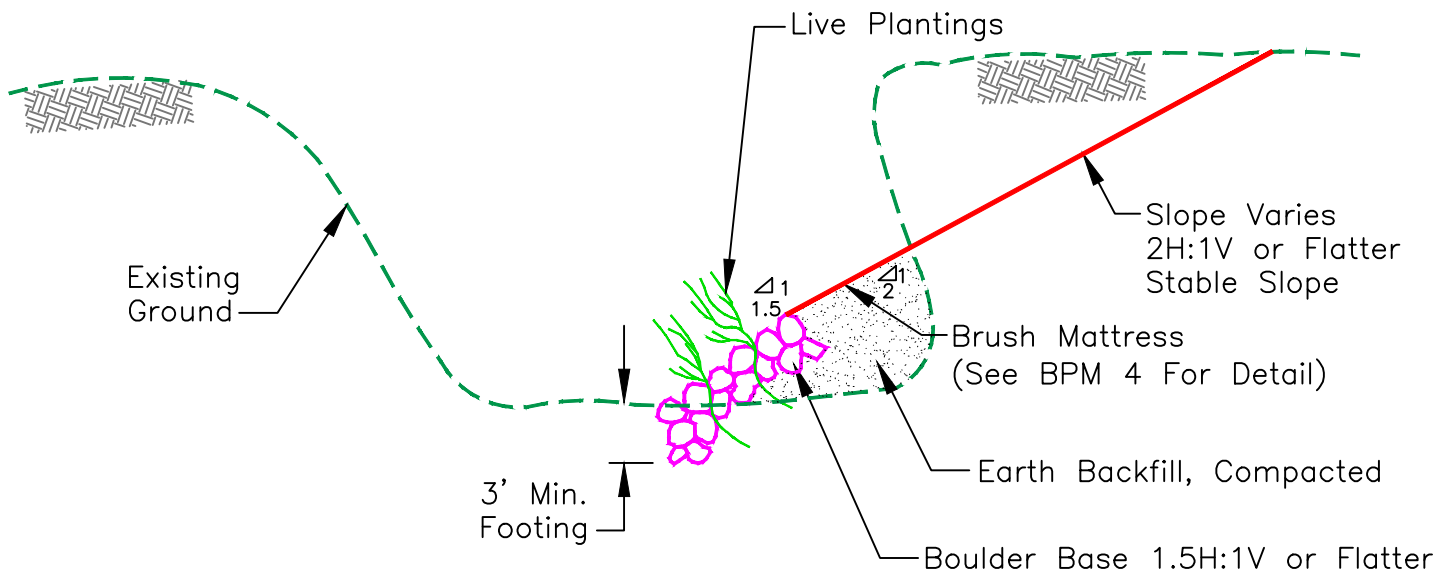

Attachment A - Bank Stabilization Methods

#4B: Brush Mattress (Brush Layering) with Log Base

Description:

Brush mattress with log base consists of grading the upper and lower portions of the eroded slope at a minimum of 2:1 and maximum of 1:1 slopes respectively, and smoothed to ensure all willows are in contact with soil. Logs are placed at the base of the native bank up to the elevation indicated by the hydraulic analysis. Where applicable and or available, rootwads may be used in combination with logs.

A maximum 2-foot deep trench is dug at the top of the log base for the butt ends of the willow branches. Wood, steel, or live willow stakes are partially driven in rows on three-foot centers in the area that will be covered by the mattress. After the stakes have been placed, live branches are put on the bank with their butt ends in the trench. Straight branches no shorter than 4 feet in length and ½-inch to 2-inch in diameter are used. If the branches are not long enough to reach the upper end of the mattress, several layers may be used; however, it is necessary to “shingle” the layers by lapping each new layer over the one below by at least 18 inches. Once the bank is covered by a thick layer of willows, cross branches are placed horizontally over the bottom layer. Stakes are then driven into the bank as deep as possible. These branches are placed against the stakes and then tied to the stakes using biodegradable wire or rope. After the completion of the mattress, the toe trench is back filled with logs to anchor the butt ends of the branches. The entire mattress is then covered by earth or fine stream material¹.

This method forms an immediate protective cover over the stream bank, captures sediment during flood flows, and rapidly restores riparian vegetation and streamside habitat. This method should not be used on slopes that are experiencing ongoing mass movement or other slope instability².

Design Criteria

Appropriate on bank slopes of 2:1 or flatter for brush mattress section of slope. 1:1 or flatter for the log base section.

Install log base with anchors. An evaluation of the vegetation communities up- and down-stream of the erosion site, the optimal vegetated habitat the site can support given the local soil, moisture, and hydraulic conditions determines appropriate vegetation species.

Appropriate for local stream velocities of 15 feet per second or less.

A typical planting plan is illustrated in Figure 10-10 of the Program Manual. Planting shall be installed as follows: Wood for mattressing shall be collected and soaked at least 10 days prior to installation. Install in location as approved by engineer. Prepare trenches. Install butt ends so that excellent contact with moist soil is maintained. Keep moist throughout installation. Live stakes/cuttings may be used as mattress stakes. Firmly attach rope to stakes in a criss-cross fashion so that bottom layer of wood is in contact with slope. Provide supplemental irrigation if needed. An as-built planting plan diagram (to scale) and plant list will be provided to the permitting agencies.

Habitat Impact Assessment:

Channel bottom: Enhances biotic resources
Bank: Enhances biotic resources

Mitigation: On-site as specified in Table 10-6 and the SMP permits. The revegetation effort will be monitored and tracked as set forth in the Manual and SMP permits until the established success criteria are met.

¹Source: Adapted from Natural Resources Conservation Service. Stream Corridor Restoration Principles, Processes and Practices

²Source: California Department of Fish and Game. California Salmonid Stream Habitat Restoration Manual

Attachment A – Bank Stabilization Methods

#4B: Brush Mattress (Brush Layering) with Log Base

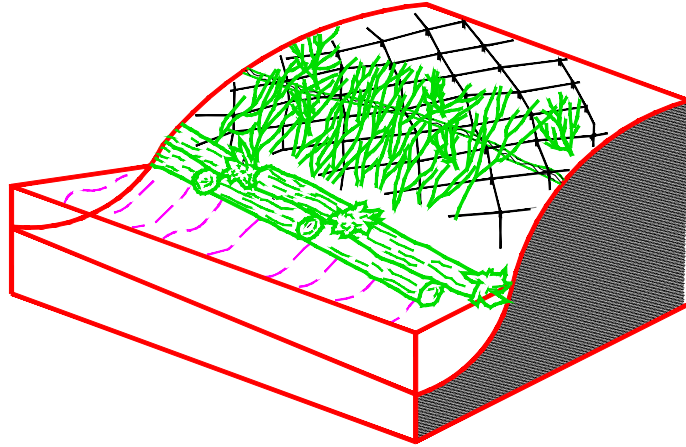

Source: Natural Resources Conservation Service, Stream Corridor Restoration Principles, Processes and Practices

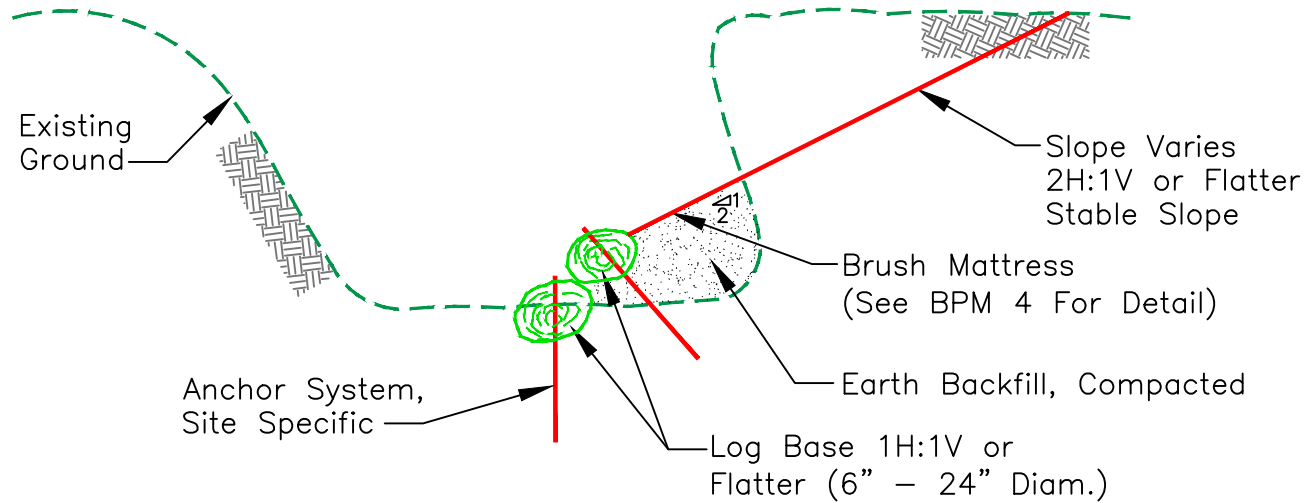

SECTION

Source: Adapted from California Department of Fish and Game. California Salmonid Stream Habitat Restoration Manual

Attachment A - Bank Stabilization Methods

#5: Surface Matting (Erosion Mats)

Description:

This method consists of securing, jute, or geotextile erosion control fabric to channel banks using stakes or staples. These materials provide soft armor protection against erosive forces and are combined with plantings. Abrasive sediment, debris, foot traffic, and sunlight will wear, snag, and tear these fabrics with time, potentially undermining the structure. These methods are intended to be the skeleton of a vegetated erosion control system. The establishment of vegetation is crucial to the long-term success of erosion mats.

Works best in small, uniform, improved channels with mild bank slopes. This method has good revegetation potential. Baseprotection is required where scour is anticipated at the base of the slope (see bank stabilization methods 5A and 5B).

Design Criteria:

Appropriate on bank slopes of 2:1 or flatter.

Typically appropriate for local stream velocities of 12 feet per second or less depending on the type of erosion mat and revegetation method selected.

A typical planting plan is illustrated in Figure 10-10 of the Program Manual. Plantings will be installed as follows: Plant palette will be based on an evaluation of vegetation communities up and down stream of the repair site, and the optimal vegetated habitat the site can support given the local soil, moisture, and hydraulic conditions, as well as erosion control effectiveness. A mix of tree, shrub, and herbaceous species will be selected as appropriate from the SMP Table 10-7. Grass species utilized will be SCVWD Erosion Control Mix per Table 10-7. An as-built planting plan diagram (to scale) and plant list will be provided to the permitting agencies.

Herbaceous species:	4 feet average on-center
Shrub species:	8 feet average on-center
Tree species:	12 feet average on-center
Live Stakes/Cuttings:	2 feet average on-center or as log placement allows

Habitat Impact Assessment:

Channel bottom:	Enhances biotic resources
Bank:	Enhances biotic resources

Mitigation: On-site as specified in Table 10-6 and the SMP permits. This repair method includes revegetation of the repair area using native species. The revegetation effort will be monitored and tracked as set forth in the Manual and SMP permits until the established success criteria are met.

Attachment A – Bank Stabilization Methods
#5: Surface Matting (Erosion Mats)

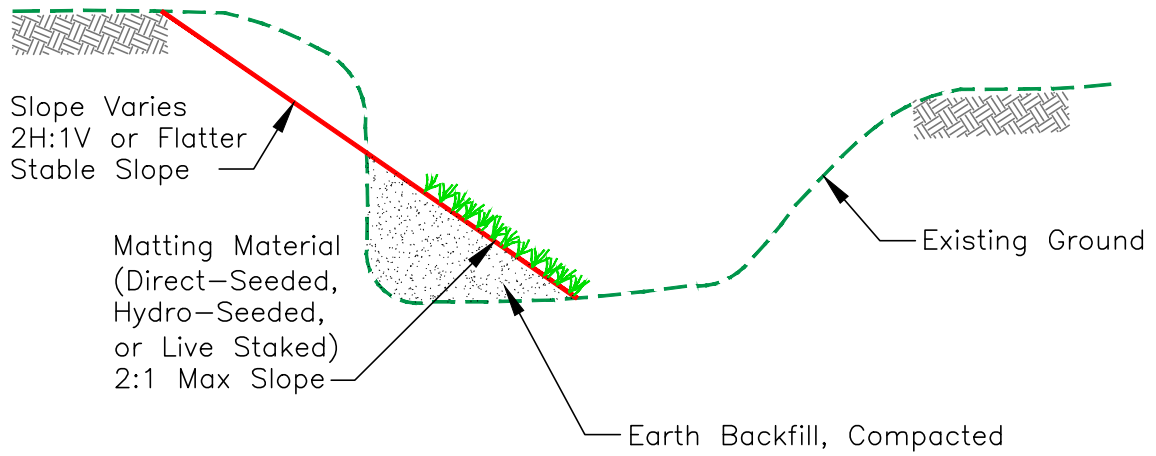

SECTION

#5 Surface Matting (Erosion Mats)



Before –Guadalupe River d/s Trimble



After – Guadalupe River d/s Trimble

Attachment A - Bank Stabilization Methods

#5A: Surface Matting (Erosion Mats) with Boulder Base

The lower portion of the eroded slope (below the elevation indicated by the hydraulic analysis) is graded at a maximum of 1.5:1 slope. The upper portion of the slope is graded at a minimum slope of 2:1 and smoothed to ensure erosion mat is in full contact with soil. Appropriately-sized boulders are placed at the base of the rebuilt bank up to the elevation indicated by the hydraulic analysis. Voids between the boulders can be planted.

In the upper portion of the slope, jute, or geotextile erosion control fabric is attached to channel banks using staking or staples. These materials provide soft armor protection against erosive forces and are combined with planting. Debris, foot traffic, and sunlight will wear, snag, and tear these fabrics with time. The boulder base protection will prevent undermining of the structure. These methods are intended to be the skeleton of a vegetated erosion control system.

Works best in uniform improved channels with mild bank slopes. This method has good revegetation potential.

Design Criteria:

Appropriate on bank slopes of 2:1 or flatter for erosion mat section of slope. 1.5:1 or flatter for the boulder section.

Boulders must be keyed in (minimum 3-foot depth) at the base of the bank.

Appropriate for local stream velocities of 6 feet per second or less if boulders are planted with live stakes; 12 feet per second if boulders are not planted.

A typical planting plan is illustrated in Figure 10-10 of the Program Manual. Plantings will be installed as follows: Plant palette will be based on an evaluation of vegetation communities up and down stream of the repair site. A mix of tree, shrub, and herbaceous species will be selected as appropriate from the SMP Table 10-7. Grass species utilized will be SCVWD Erosion Control Mix per Table 10-7. An as-built planting plan diagram (to scale) and plant list will be provided to the permitting agencies.

Herbaceous species:	4 feet average on-center
Shrub species:	8 feet average on-center
Tree species:	12 feet average on-center
Live Stakes/Cuttings:	2 feet average on-center or as log placement allows

Habitat Impact Assessment:

Channel bottom:	Enhances biotic resources
Bank:	Enhances biotic resources

Mitigation: On-site/off-site as specified in Table 10-6 and the SMP permits. This repair method includes revegetation of the repair area using native species. The revegetation effort will be monitored and tracked as set forth in the Manual and SMP permits until the established success criteria are met.

Attachment A – Bank Stabilization Methods

#5A: Surface Matting (Erosion Mats) with Boulder Base

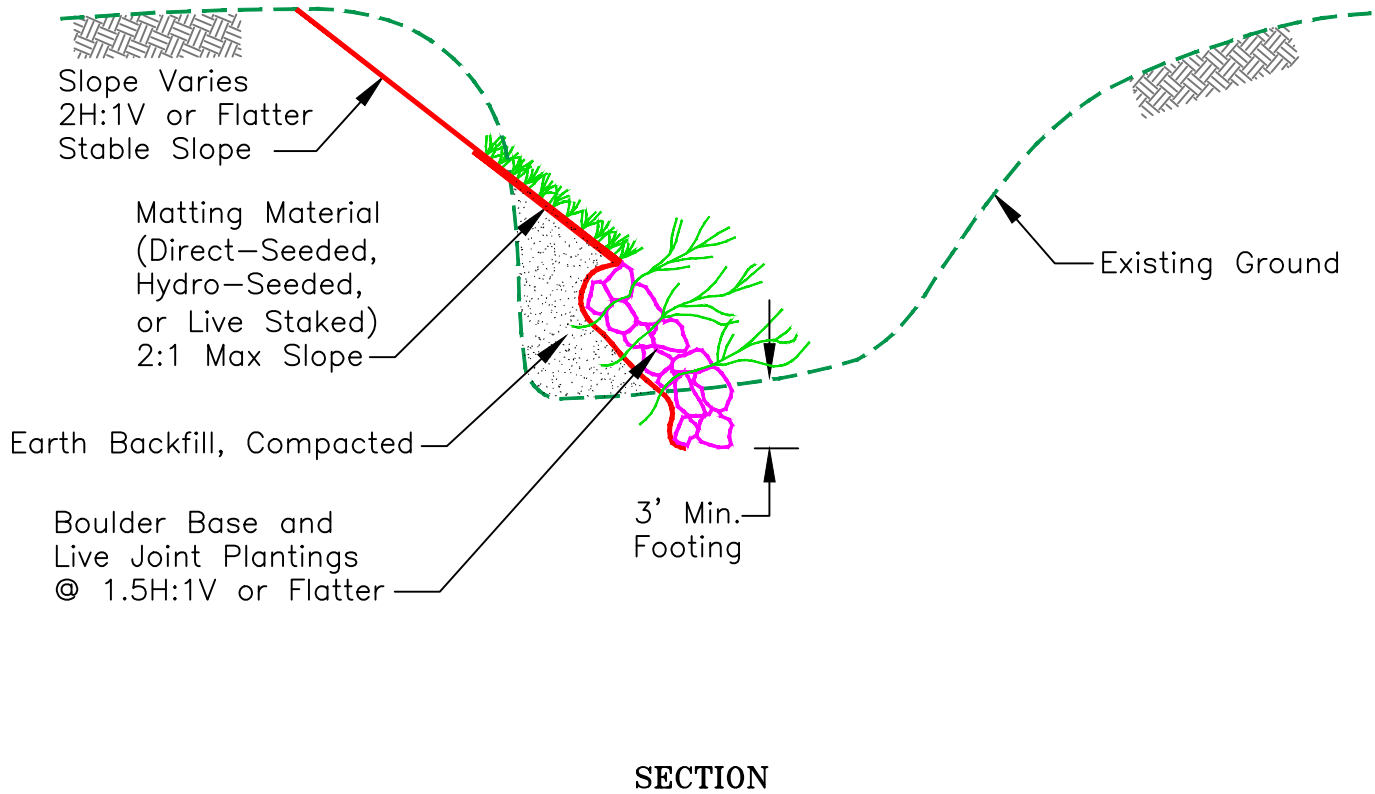

#5A: Surface Matting (Erosion Mats) with Boulder Base (Hybrid)



Before –Veg Saratoga Creek d/s Bollinger



After – Veg Saratoga Creek d/s Bollinger

#5A: Surface Matting (Erosion Mats) with Boulder Base (Hard)



Before – Greystone Creek u/s Olive Branch



After – Greystone Creek u/s Olive Branch

Attachment A - Bank Stabilization Methods

#5B: Surface Matting (Erosion Mats) with Log Base

Description:

Surface matting with log base consists of grading the upper and lower portions of the eroded slope (up to the elevation indicated by the hydraulic analysis) at a minimum of 2:1 and maximum of 1.5:1 slopes respectively, and smoothed to ensure erosion mat is in full contact with soil. Logs are placed at the base of the native bank up to the elevation indicated by the hydraulic analysis. Root wads may be used, where applicable and/or available.

In the upper portion of the slope, jute, or geotextile erosion control fabric is attached to channel banks using stakes, staples, or anchors. These materials provide soft armor protection against erosive forces and are combined with planting. Debris, foot traffic, and sunlight may wear, snag, and tear these fabrics with time. The log base protection will prevent undermining of the structure. These methods are intended to be the skeleton of a vegetated erosion control system.

This repair type works best in uniform improved channels with mild bank slopes and has good revegetation potential.

Design Criteria:

Appropriate on bank slopes of 2:1 or flatter for erosion mat section of slope. 1.5:1 or flatter for the log section.

Install the log base with anchors.

Appropriate for local stream velocities of 15 feet per second or less.

A typical planting plan is illustrated in Figure 10-10 of the Program Manual. Plantings will be installed as follows: Plant palette will be based on an evaluation of vegetation communities up and down stream of the repair site. A mix of tree, shrub, and herbaceous species will be selected as appropriate from the SMP Table 10-7. Grass species utilized will be SCVWD Erosion Control Mix per Table 10-7. An as-built planting plan diagram (to scale) and plant list will be provided to the permitting agencies.

Plantings will be installed as follows:

Herbaceous species:	4 feet average on-center
Shrub species:	8 feet average on-center
Tree species:	12 feet average on-center
Live Stakes/Cuttings:	2 feet average on-center or as log placement allows

Habitat Impact Assessment:

Channel bottom:	Enhances biotic resources
Bank:	Enhances biotic resources

Mitigation: On-site as specified in Table 10-6 and the SMP permits. The revegetation effort will be monitored and tracked as set forth in the Manual and SMP permits until the established success criteria are met.

Attachment A – Bank Stabilization Methods

#5B: Surface Matting (Erosion Mats) with Log Base

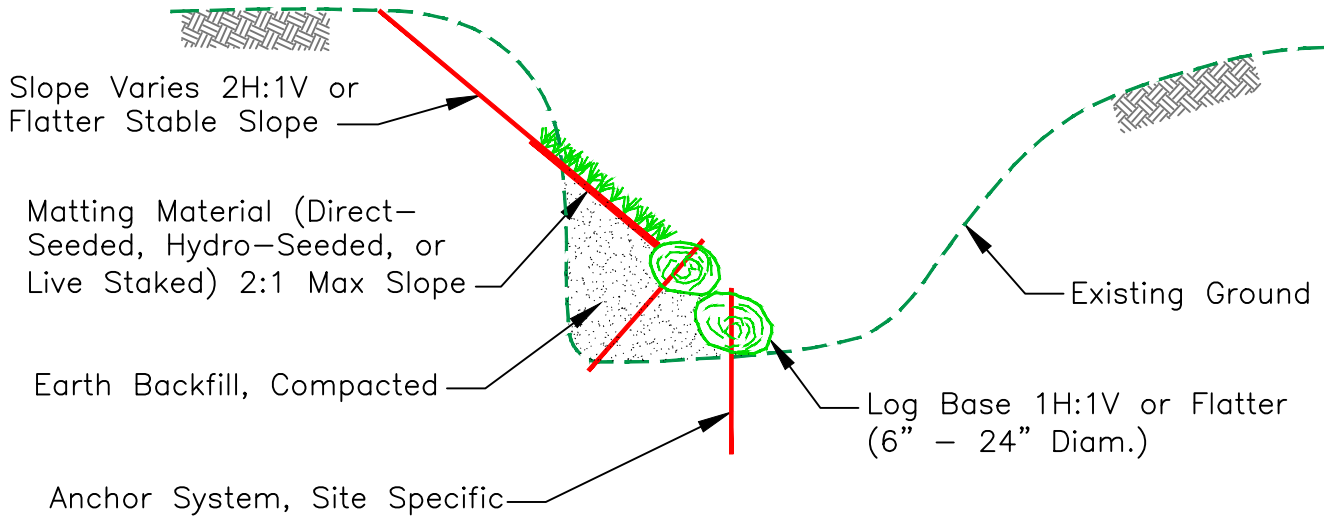

SECTION

Attachment A - Bank Stabilization Methods

#6: Add Rock to Invert

Description:

This is a technique most commonly used to armor a channel invert susceptible to incision or scour downstream of various control structures such as bridges or concrete channels. Rock channel bottoms can also be valuable in terms of reoxygenation of water in the creek. This installation method can also retard stream turbidity in many cases¹.

Rocks are placed in scour holes or along the invert for the appropriate length as indicated by the hydraulic analysis, depending on the length and depth of repair needed. This can include scour holes just downstream of a drop structure that needs armoring, or an entire reach of channel can be armored with well-graded, angular rock to stop incision. If lining a long length of channel, rocks can be formed into a concave shape and a key can be constructed every few hundred feet to stabilize the lining.

Design Criteria:

Appropriate for incised channels or scour holes downstream of a concrete portion of creek.

Habitat Impact Assessment:

Channel bottom: May adversely impact biotic resources
Bank: May adversely impact biotic resources

Mitigation: Off-site as specified in Table 10-6 and the SMP permits.

¹Source: Santa Clara Valley Water District, Design Manual, Open Channel Hydraulics and Sediment Transport, June 2009

#6: Add Rock to Invert



Before – Regnart Creek d/s Pacifica



After – Regnart Creek d/s Pacifica

Attachment A - Bank Stabilization Methods

#6A: Rock Cross Vanes

Description:

The cross-vane is a grade control structure that decreases near-bank shear stress, velocity and stream power, but increases the energy in the center of the channel. The structure will establish grade control, reduce bank erosion, create a stable width/depth ratio, and maintain channel capacity, while maintaining sediment transport capacity and sediment competence. The cross-vane is also a stream habitat improvement structure.

The cross-vane is typically composed of a row of header rocks and a row of footer rocks. The header rocks can be installed with half of its size embedded below the final grade. The footer rocks are installed downstream of and at a lower elevation than the header rocks to provide support. The top of the footer rocks are positioned at the final grade².

With the channel boundary opening up at the floodplain level, the vane may be properly keyed into the side slopes, an advantage not easily afforded by incised channels². Each leg of the vane typically makes an angle of 20-30 degrees with the bank¹.

Design Criteria:

Appropriate in "B" and "F" type channels, according to Rosgen's stream classification system.

Habitat Impact Assessment:

Channel bottom: Enhances biotic resources
Bank: Enhances biotic resources

Mitigation: On-site/off-site as specified in Table 10-6 and the SMP permits. The revegetation effort will be monitored and tracked as set forth in the Manual and SMP permits until the established success criteria are met. An as-built planting plan diagram (to scale) and plant list will be provided to the permitting agencies. Permanent impacts associated with rock placement will be mitigated on-site through a NMFS-approved methodology as described in Chapter 10 of the Manual. No additional mitigation is required if the agencies provide written concurrence that rock placed along the channel bed provides habitat complexity functions.

¹Source: Wildland Hydrology, Inc.; Rosgen, David L.P.H.; "The Cross-Vane, W-Weir and J-Hook Vane Structures...Their Description, Design and Application for Stream Stabilization and River Restoration".

²Source: Santa Clara Valley Water District, Design Manual, Open Channel Hydraulics and Sediment Transport, June 2009

Attachment A – Bank Stabilization Methods
#6A: Rock Cross-Vanes

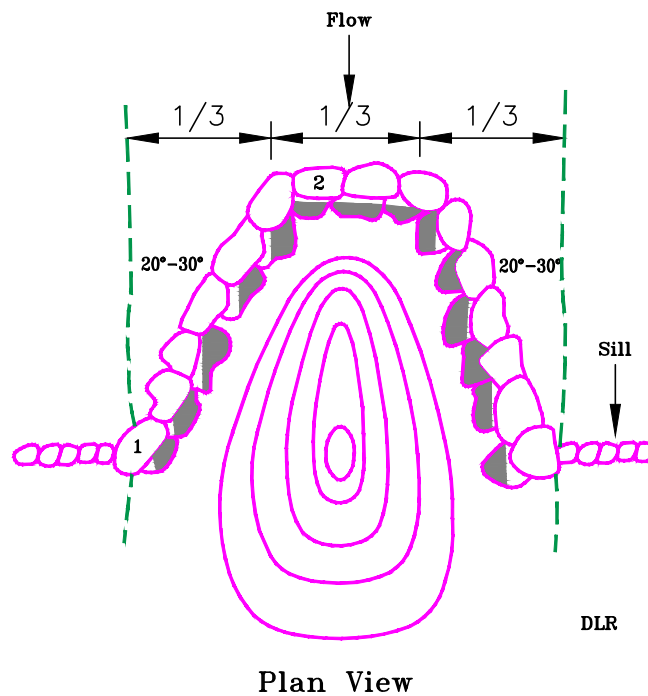
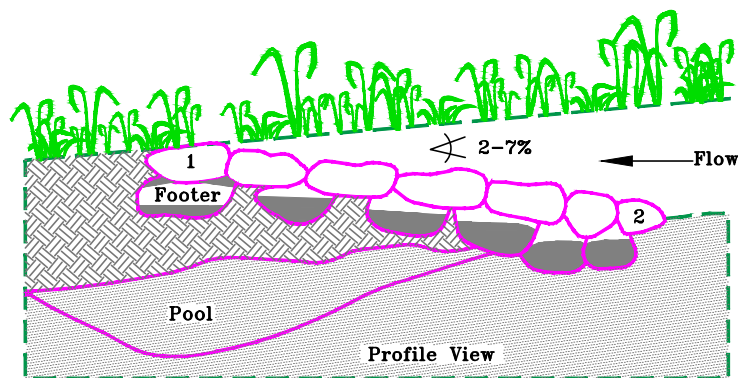
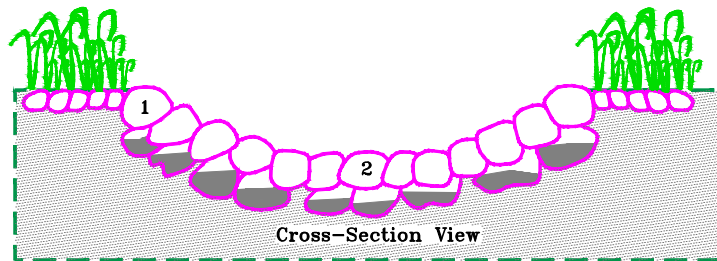

Source: Wildland Hydrology, Inc.: Rosgen, David L, P.H.; "The Cross-Vane, W-Weir and J-Hook Vane Structures...
Their Description, Design and Application for Stream Stabilization and River Restoration".

#6A: Rock Cross Vanes



Before – Permanente Creek u/s Charlston



After – Permanente Creek u/s Charlston

Attachment A - Bank Stabilization Methods

#6B: Root Wads and Boulders

Description:

This method combines boulders, logs, and live plant material to armor a stream bank. Fish habitat is enhanced in addition to creating a natural-looking bank stabilization structure¹.

Footer logs are set in a toe trench below the thalweg line with the channel end pointed downstream and the butt end angled 45 to 60 degrees upstream. A second log (with root wad) is set on top of the footer log diagonally, forming an "X". The root wad end is set pointing upstream and the butt end lying downstream 45 to 60 degrees. The apex of the logs is anchored together using boulders, re-bar or cables. Large boulders are placed on top and between the logs at each apex. After all the logs and boulders are set in place, live plant material such as willows is placed within the spaces of the structure, behind the boulders. Excavated gravel and stream materials can then be placed over the bank end portion of the structure.

This method will tolerate high boundary shear stresses if logs and root wads are well-anchored. This method should, where appropriate, be used in conjunction with soil bioengineering or live vegetation plantings to stabilize the upper bank and ensure a regenerative source of stream bank vegetation. The life of the structure depends on the species of logs used. It might need replacement if vegetative colonization does not take place. This method can create local scour (channel bottom) and erosion (opposite bank)².

Design Criteria:

Appropriate for channel velocities at 10 feet per second or less.

A typical planting plan is illustrated in Figure 10-10 of the Program Manual. Plantings will be installed as follows: Plant palette will be based on an evaluation of vegetation communities up and down stream of the repair site. A mix of tree, shrub, and herbaceous species will be selected as appropriate from the SMP Table 10-7. Grass species utilized will be SCVWD Erosion Control Mix per Table 10-7. An as-built planting plan diagram (to scale) and plant list will be provided to the permitting agencies.

Herbaceous species:	4 feet average on-center
Shrub species:	8 feet average on-center
Tree species:	12 feet average on-center
Live Stakes/Cuttings:	2 feet average on-center or as log placement allows

Habitat Impact Assessment:

Channel bottom:	Enhances biotic resources
Bank:	Enhances biotic resources

Mitigation: On-site as specified in Table 10-6 and the SMP permits. The revegetation effort will be monitored and tracked as set forth in the Manual and SMP permits until the established success criteria are met.

¹Source: California Department of Fish and Game. California Salmonid Stream Habitat Restoration Manual

²Source: Natural Resources Conservation Service. Stream Corridor Restoration Principles, Processes and Practices

Attachment A – Bank Stabilization Methods
#6B: Root Wads and Boulders

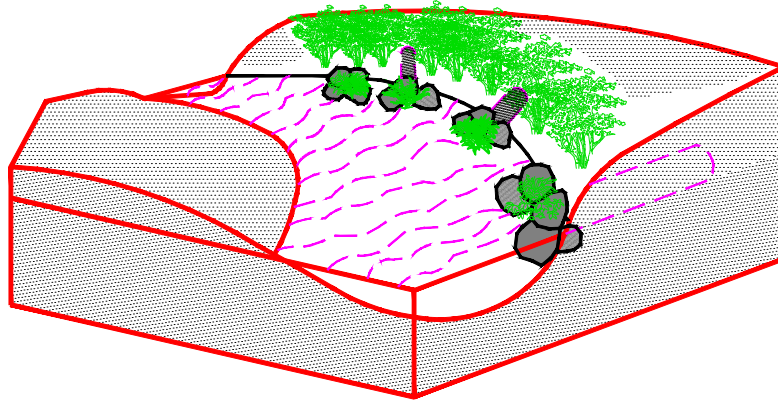

Source: Adapted from Natural Resources Conservation Service, Stream Corridor Restoration Principles, Processes and Practices

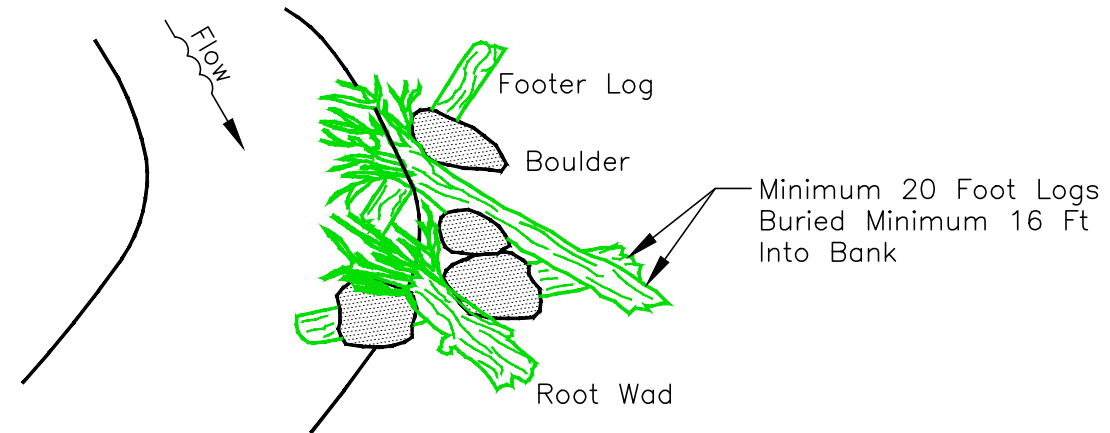

Plan

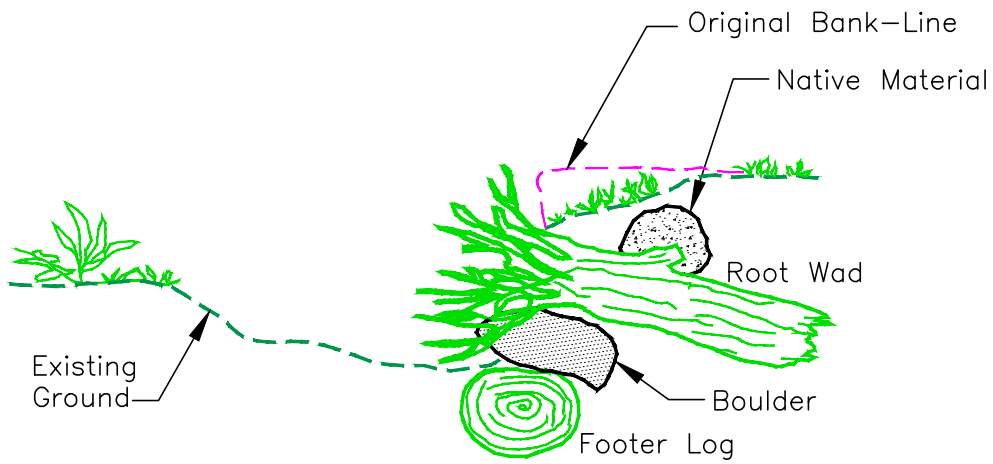

SECTION

Source: Adapted from California Department of Fish and Game, California Salmonid Stream Habitat Restoration Manual

Attachment A - Bank Stabilization Methods

#6C: Live Log Crib Walls

Description:

Log crib walls are used to reduce sediment input and protect banks in areas where logs are available and boulders are not practical¹. Cribbing provides protection in areas with near-vertical banks where bank sloping options are limited by issues such as right of way restrictions². Crib walls afford a natural appearance, immediate protection, and accelerate the establishment of woody species². This method is effective on the outside of bends where high velocities are present and in situations where a low wall may be required to stabilize the base of the bank and reduce slope steepness². This method does not adjust to toe scour and should be used in combination with soil bioengineering systems and live plantings to stabilize the upper slopes². Logs should be selected for soundness, durability, uniformity of size, and ease of handling (straight logs much preferred) and delivery.

Two rows of base logs or untreated timbers are placed in trenches below stream grade to prevent undercutting of the structure. Base logs should be as large (long and thick) as can be manipulated while conforming to the contour of the stream bank. Good base logs are crucial to ensure stability and durability of the cribwall¹. Geotextile fabric should be placed behind and inside the face of (to keep material in) the structure. Tie-back logs are notched, nailed, or bolted into the base logs and placed at regular intervals (6 to 8 feet typically) along the base logs. Tie-back logs are attached to both rows of base logs. Once the first row of tie-back logs has been connected a second set of face logs is placed on top of the tie-backs. These logs are placed approximately 6 inches back into the slope. This procedure is repeated until the desired level of bank protection is achieved. As each lift is constructed, the face logs and tie-backs are filled with a mix of gravel and cobbles to the top of the face log. It is not necessary to use topsoil in the fill material; but there should be sufficient fine grained material to insure vegetation growth. Live cuttings are then laid in to form a complete cover layer. These live branches should be long enough to have their butt end in the native soil behind the crib wall. The tips should stick out of the crib wall no more than a quarter of the cutting total length. The branches are then covered with gravel/cobble mix to the top of the tie-backs and the next layer is continued.

Design Criteria:

Appropriate for slopes up to ¼:1.

Appropriate for velocities from 6 feet per second up to 12 feet per second, depending on opening size.

A typical planting plan is illustrated in Figure 10-9 of the Program Manual. Plantings will be installed as follows: Plant palette will be based on an evaluation of vegetation communities up and down stream of the repair site. A mix of tree, shrub, and herbaceous species will be selected as appropriate from the SMP Table 10-8. Grass species utilized will be SCVWD Erosion Control Mix per Table 10-8. An as-built planting plan diagram (to scale) and plant list will be provided to the permitting agencies.

Herbaceous species:	4 feet average on-center
Shrub species:	8 feet average on-center
Tree species:	12 feet average on-center
Live Stakes/Cuttings:	2 feet average on-center or as log placement allows

Habitat Impact Assessment:

Channel bottom:	Minimizes further degradation of biotic resources, with limited revegetation potential.
Bank:	Minimizes further degradation of biotic resources, with limited revegetation potential.

Attachment A - Bank Stabilization Methods

Mitigation: On-site as specified in Table 10-6 and the SMP permits. The revegetation effort will be monitored and tracked as set forth in the Manual and SMP permits until the established success criteria are met.

¹Source: California Department of Fish and Game. California Salmonid Stream Habitat Restoration Manual

²Source: Natural Resources Conservation Service. Stream Corridor Restoration Principles, Processes and Practices

Attachment A – Bank Stabilization Methods
#6C: Live Log Crib Walls

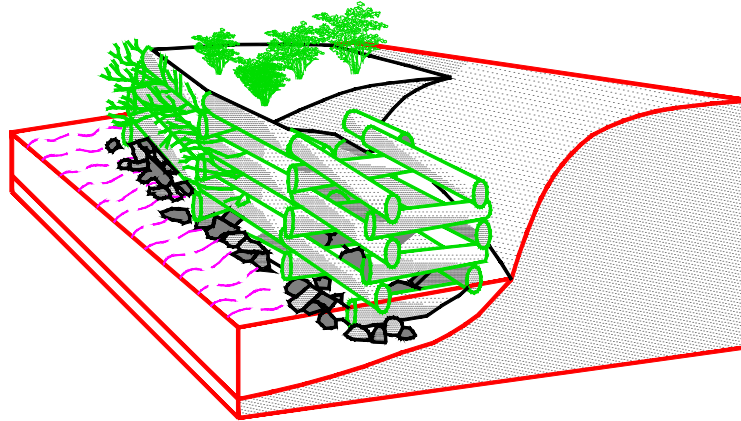

Source: Natural Resources Conservation Service, Stream Corridor Restoration Principles, Processes and Practices

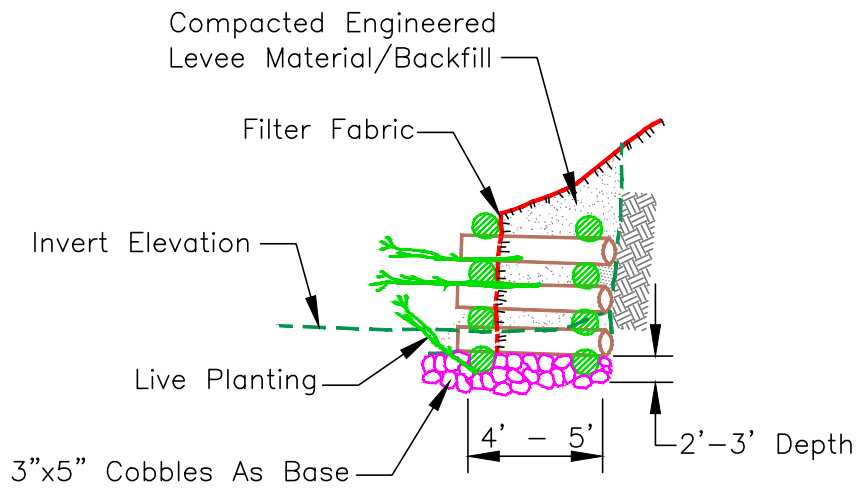

SECTION

Source: Adapted from California Department of Fish and Game, California Salmonid Stream Habitat Restoration Manual

Attachment A - Bank Stabilization Methods

#6D: Log Revetment

Description:

For sites where erosion has cut out the base of the bank and a portion of a steep bank and there is no room for shaping back the bank slope, log revetment may be used for bank repair. Log revetment is a stack of logs that forms the protected bank slope with compacted soil backfill behind the logs. Each individual log is anchored to the foundation and rebar is used to connect logs to each other. The logs are cut to fit the size of the eroded bank. There is minimal excavation except to clear away debris and loose materials. Live tree roots are saved as much as possible by burying them in the soil backfill¹.

Log revetment will be mitered to match the upstream and downstream bank slopes. The bottom log of the log revetment is aligned with the upstream and downstream toe line to minimize encroachment into the flow area¹. Two adjacent logs are laid below grade to act as a footing for the structure. These footer logs are anchored into the native ground using either rebar or duckbill anchors and cable, or some other site-appropriate anchoring method. Logs are then stacked one on top of the other, at the appropriate slope, and are rebarred to one another. Each log is anchored into existing ground using duckbill anchors and cable, rebar, or another site-appropriate method, until the appropriate height is obtained.

Design Criteria:

Appropriate on steep bank slopes $\frac{1}{4}$:1 or flatter.

Appropriate for velocities up to 15 feet per second.

Habitat Impact Assessment:

Channel bottom:	Enhances biotic resources
Bank:	Enhances biotic resources

Mitigation: On-site/off-site as specified in Table 10-6 and the SMP permits. The revegetation effort will be monitored and tracked as set forth in the Manual and SMP permits until the established success criteria are met.

¹Source: Santa Clara Valley Water District, Design Manual, Open Channel Hydraulics and Sediment Transport, June 2009

Attachment A – Bank Stabilization Methods
#6D: Log Revetment

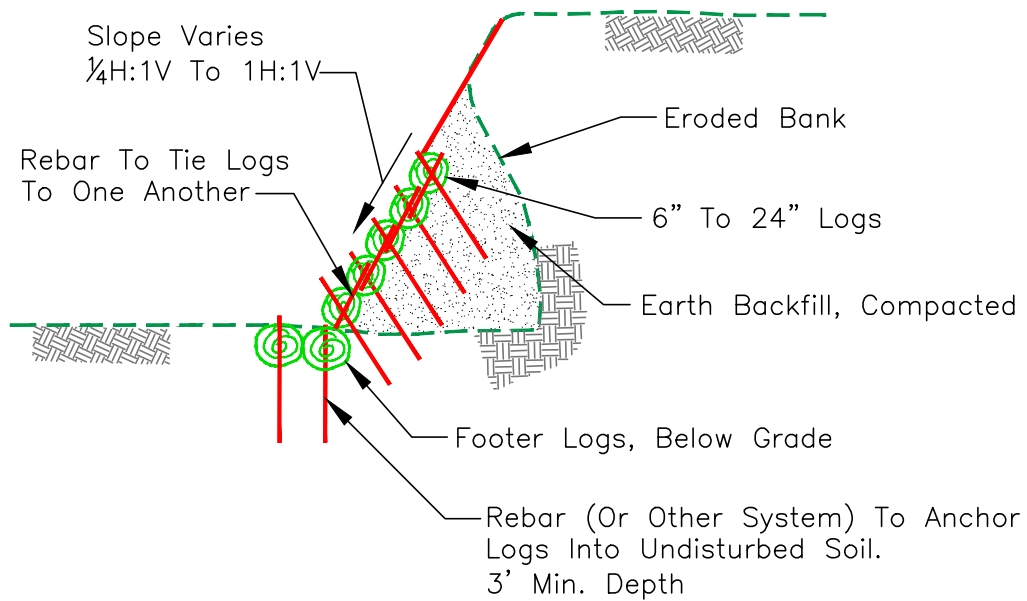

SECTION

Attachment A - Bank Stabilization Methods

#7: Cellular Confinement System

Description:

Soil cellular confinement system (geocell) is a polyethylene plastic cellular system where structural strength is developed by the composite design of soil, plant roots, and the plastic's cellular configuration. This system is available in 8-inch deep honeycomb mats that are installed in offset vertical layers to create terraced planting areas. The honeycomb cells are filled with soil, moderately compacted, and planted with woody vegetation and grasses. The structure functions similarly to a crib wall structure.

This method has limited potential for vegetation establishment.

Design Criteria:

Appropriate for slopes up to ½:1.

Appropriate for velocities up to 6 feet per second.

A typical planting plan is illustrated in Figure 10-10 of the Program Manual. Plantings will be installed as follows: Plant palette will be based on an evaluation of vegetation communities up and down stream of the repair site. A mix of tree, shrub, and herbaceous species will be selected as appropriate from the SMP Table 10-7. Grass species utilized will be SCVWD Erosion Control Mix per Table 10-7. An as-built planting plan diagram (to scale) and plant list will be provided to the permitting agencies.

Herbaceous species:	4 feet average on-center
Shrub species:	8 feet average on-center
Tree species:	12 feet average on-center
Live Stakes/Cuttings:	2 feet average on-center or as log placement allows

Habitat Impact Assessment:

Channel bottom:	Permanent impact
Bank:	Permanent impact

Mitigation: Off-site as specified in Table 10-6 and the SMP permits.

Attachment A – Bank Stabilization Methods
#7: Cellular Confinement System

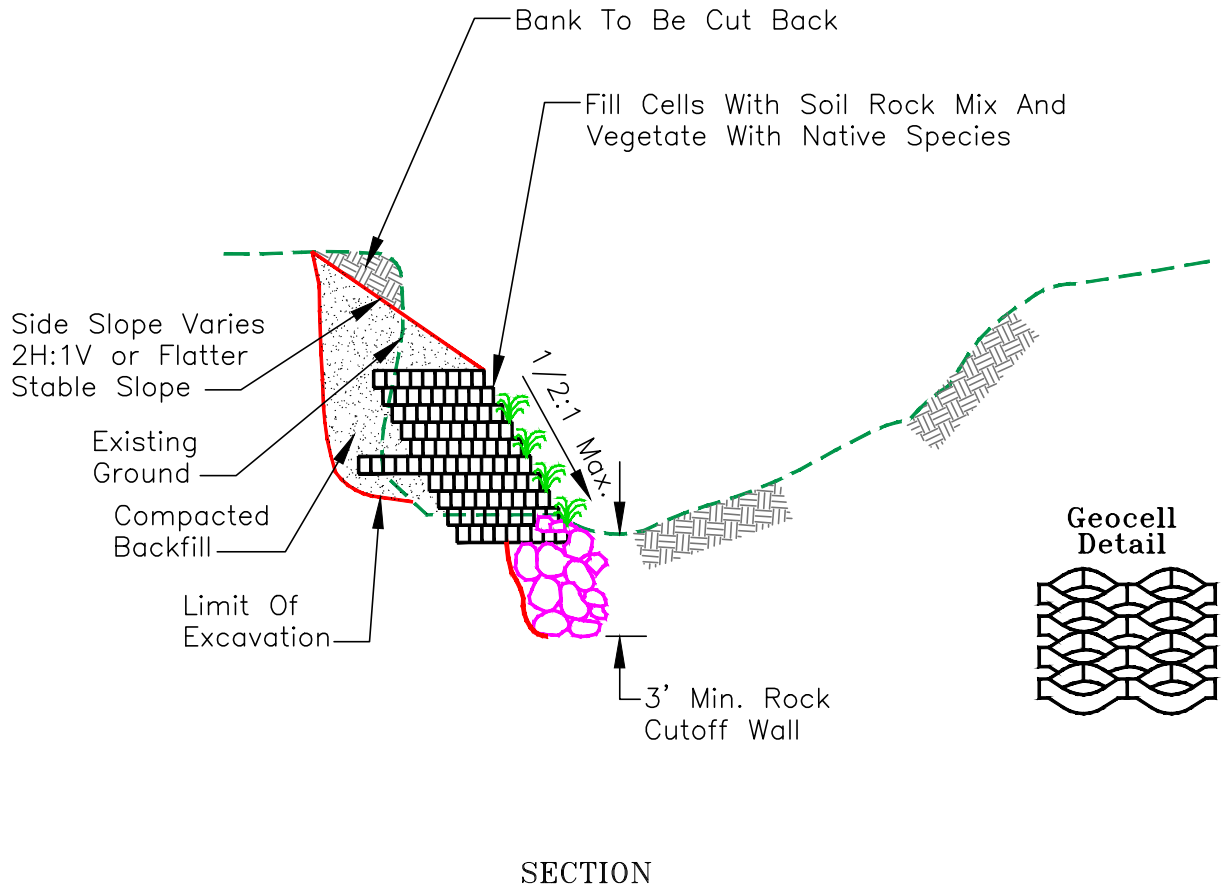

Attachment A - Bank Stabilization Methods

#8: Rock Blanket

Description:

This method consists of placing a blanket of appropriately-sized rock over the bank, to the extent indicated by the hydraulic analysis, to control erosion. Smaller cobbles may be placed in the voids of the rock to create a solid structure so as to minimize scour behind the rock and failure of the structure. This method is appropriate where long-term durability is needed, design discharge is high, there is significant threat to life or property, or there is no practical way to otherwise incorporate vegetation into the design. This method should, where appropriate, be used with soil-bioengineering systems or live vegetation to stabilize the upper bank and ensure a regenerative source of streambank vegetation. A major benefit to this method is that the components are flexible and function is not impaired by slight movement from settlement or other adjustments¹.

Angular rock should be used, because they tend to interlock, making the structure act like a single structure rather than a collection independent stones.

Design Criteria:

Appropriate for slopes up to 1.5:1, preferably 2:1.

Rock sizes of 6 inches to 18 inches in diameter.

Appropriate for velocities up to 15 feet per second.

A typical planting plan is illustrated in Figure 10-10 of the Program Manual. Plantings will be installed as follows: Plant palette will be based on an evaluation of vegetation communities up and down stream of the repair site. A mix of tree, shrub, and herbaceous species will be selected as appropriate from the SMP Table 10-7. Grass species utilized will be SCVWD Erosion Control Mix per Table 10-7. An as-built planting plan diagram (to scale) and plant list will be provided to the permitting agencies.

Herbaceous species:	4 feet average on-center
Shrub species:	8 feet average on-center
Tree species:	12 feet average on-center
Live Stakes/Cuttings:	2 feet average on-center or as log placement allows

Habitat Impact Assessment:

Channel bottom: Permanent Impact

Bank: Permanent Impact

Mitigation: Off-site as specified in Table 10-6 and the SMP permits.

¹Source: Adapted from Natural Resources Conservation Service. Stream Corridor Restoration Principles, Processes and Practices

Attachment A – Bank Stabilization Methods
#8: Rock Blanket

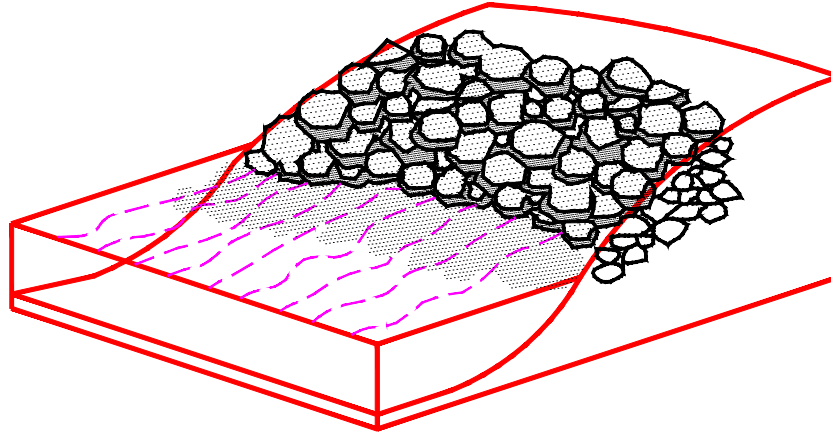

Source: Natural Resources Conservation Service, Stream Corridor Restoration Principles, Processes and Practices

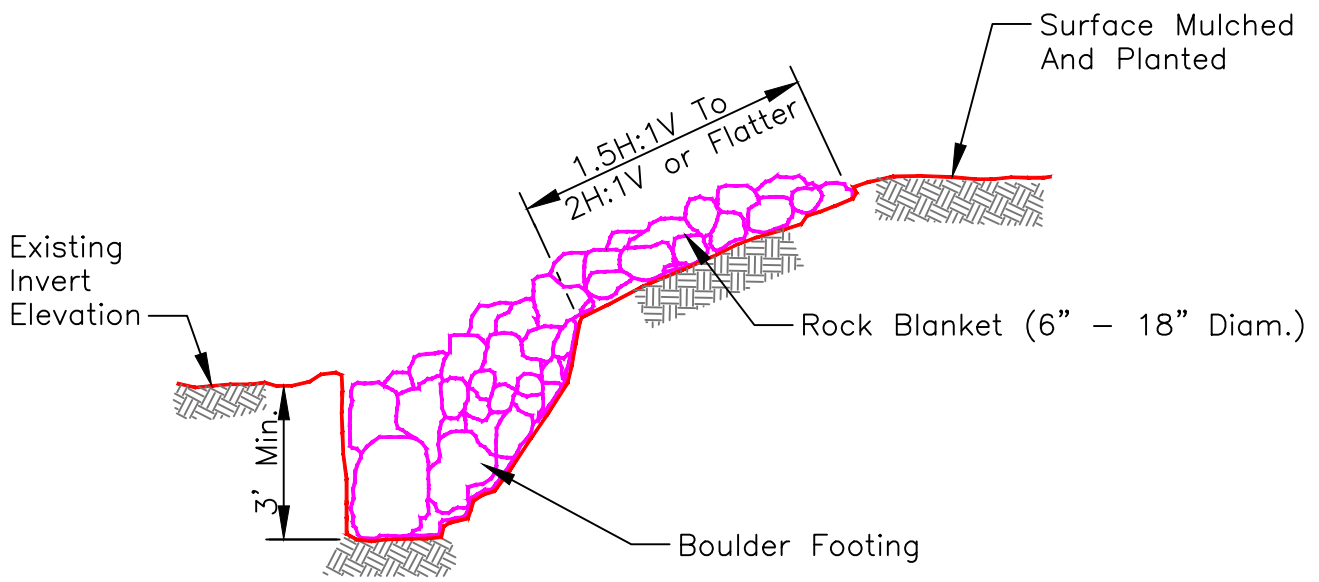

SECTION

Source: Adapted from California Department of Fish and Game. California Salmonid Stream Habitat Restoration Manual

#8: Rock Blanket



Before - Calabazas Creek d/s Bollinger



After - Calabazas Creek d/s Bollinger

Attachment A - Bank Stabilization Methods

#8A: Boulder Revetment

Description:

Boulder revetment is a method for armoring stream banks with large boulders for preventing bank erosion. Revetment footing is laid in a "toe" trench dug along the base of the bank. Large boulders are then laid on the bank slopes up to the elevation indicated by the hydraulic analysis. Large angular boulders are best suited for this purpose. Boulder revetment can provide protection in areas where log or boulder instream structures may lead to bank erosion. The boulders used should be dense and structurally competent¹.

Geotextile fabrics should be avoided, as they prevent the natural establishment of vegetation¹.

This method should, where appropriate, be used with soil bio-engineering systems or live vegetation to stabilize the upper bank and ensure a regenerative source of streambank vegetation. A major benefit of this method is that the components are flexible and function is not impaired by slight movement from settlement or other adjustments².

This structure would allow for some natural revegetation of the bank.

Design Criteria:

Appropriate for slopes up to 1:1, preferably 2:1.

Appropriate for velocities up to 6 feet per second if boulder joints are planted, 15 feet per second if boulders are not planted.

A typical planting plan is illustrated in Figure 10-10 of the Program Manual. Plantings will be installed as follows: Plant palette will be based on an evaluation of vegetation communities up and down stream of the repair site. A mix of tree, shrub, and herbaceous species will be selected as appropriate from the SMP Table 10-7. Grass species utilized will be SCVWD Erosion Control Mix per Table 10-7. An as-built planting plan diagram (to scale) and plant list will be provided to the permitting agencies.

Herbaceous species:	4 feet average on-center
Shrub species:	8 feet average on-center
Tree species:	12 feet average on-center
Live Stakes/Cuttings:	2 feet average on-center or as log placement allows

Habitat Impact Assessment:

Channel bottom:	Permanent impact
Bank:	Permanent impact

Mitigation: Off-site as specified in Table 10-6 and the SMP permits.

¹Source: Adapted from California Department of Fish and Game. California Salmonid Stream Habitat Restoration Manual

²Source: Natural Resources Conservation Service. Stream Corridor Restoration Principles, Processes and Practices

Attachment A – Bank Stabilization Methods
#8A : Boulder Revetment

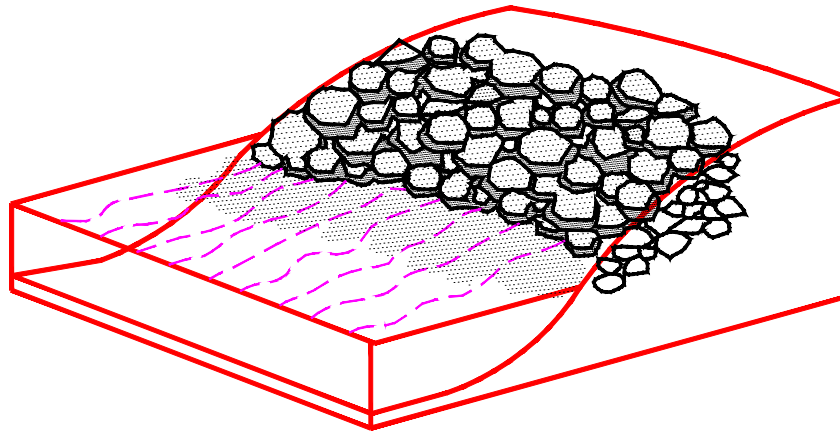

Source: Natural Resources Conservation Service, Stream Corridor Restoration Principles, Processes and Practices

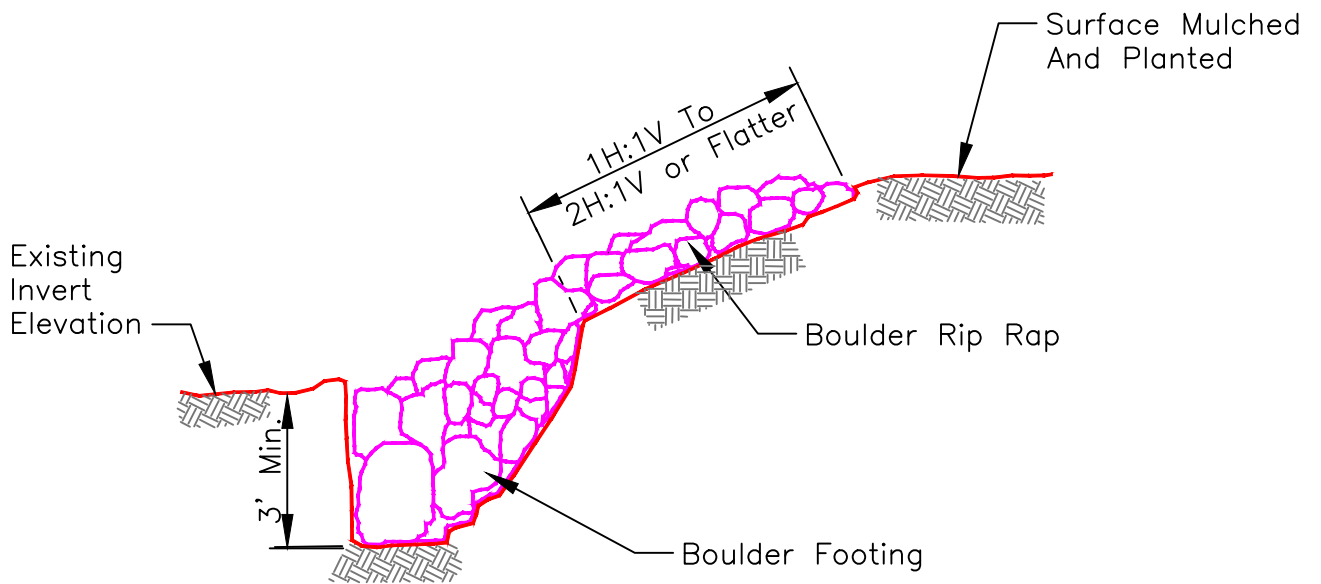

SECTION

Source: Adapted from California Department of Fish and Game. California Salmonid Stream Habitat Restoration Manual

#8A: Boulder Revetment



Before - Golf Creek d/s Culligan



After - Golf Creek d/s Culligan

Attachment A - Bank Stabilization Methods

#8B: Boulder Revetment with Soil and Vegetation

Description:

Boulder revetment is a method for armoring stream banks with large boulders for preventing bank erosion. Revetment footing is laid in a "toe" trench dug along the base of the bank. Large boulders are then laid on the bank slopes up to the elevation indicated by the hydraulic analysis. Large angular boulders are best suited for this purpose. Boulder revetment can provide protection in areas where log or boulder instream structures may lead to bank erosion. The boulders used should be dense and structurally competent¹.

Soil is placed over the boulders and vegetation is installed by staking and/or direct seeding. Bio-degradable erosion control mats may be placed over the soil to help control erosion until vegetation establishes itself. Special care must be taken in staking to avoid damage to the stakes' cambium and to ensure good soil/water/stake contact. Thick revetment layers may require special tools for establishing staking pilot holes².

Geotextile fabrics should be avoided, as they prevent the natural establishment of vegetation¹.

This method should, where appropriate, be used with soil bio-engineering systems or live vegetation to stabilize the upper bank and ensure a regenerative source of streambank vegetation. A major benefit of this method is that the components are flexible and function is not impaired by slight movement from settlement or other adjustments².

Design Criteria:

Appropriate for slopes up to 1:1, preferably 2:1.

Appropriate for velocities up to 6 feet per second.

A typical planting plan is illustrated in Figure 10-10 of the Program Manual. Plantings will be installed as follows: Plant palette will be based on an evaluation of vegetation communities up and down stream of the repair site. A mix of tree, shrub, and herbaceous species will be selected as appropriate from the SMP Table 10-7. Grass species utilized will be SCVWD Erosion Control Mix per Table 10-7. An as-built planting plan diagram (to scale) and plant list will be provided to the permitting agencies.

Herbaceous species:	4 feet average on-center
Shrub species:	8 feet average on-center
Tree species:	12 feet average on-center
Live Stakes/Cuttings:	2 feet average on-center or as log placement allows

Habitat Impact Assessment:

Channel bottom:	Enhances biotic resources.
Bank:	Provides limited biotic resources.

Mitigation: On-site/off-site as specified in Table 10-6 and the SMP permits. This method includes replanting of the repair area. Mitigation may be required depending on whether or not this method is used with soil bio-engineering systems or live vegetation to stabilize the upper bank and ensure a regenerative source of streambank vegetation. The revegetation effort will be monitored and tracked as set forth in the Manual and SMP permits until the established success criteria are met.

¹Source: Adapted from California Department of Fish and Game. California Salmonid Stream Habitat Restoration Manual

²Source: Adapted from Natural Resources Conservation Service. Stream Corridor Restoration Principles, Processes and Practices

Attachment A – Bank Stabilization Methods
#8B: Boulder Revetment
with Soil and Vegetation

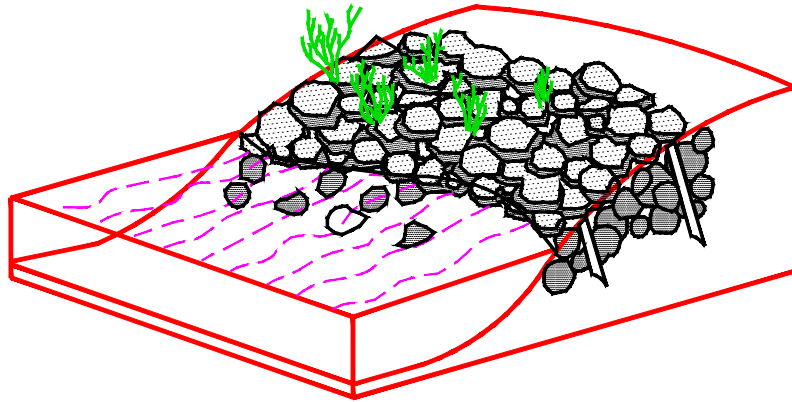

Source: Natural Resources Conservation Service, Stream Corridor Restoration Principles, Processes and Practices

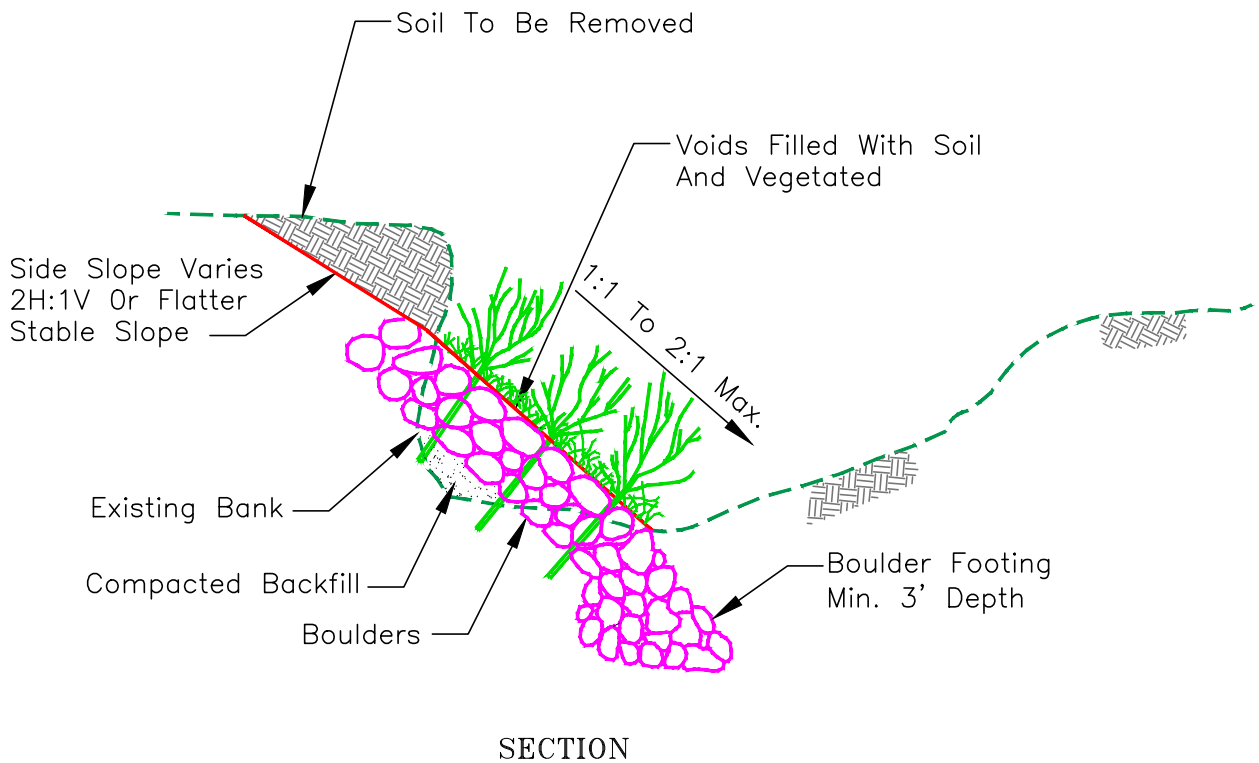

#8B: Boulder Revetment with Soil and Vegetation



Before – Ross Creek u/s Los Gatos-Almaden



After - Ross Creek u/s Los Gatos-Almaden

Attachment A - Bank Stabilization Methods

#9: Articulated Concrete Blocks

Description:

Articulated concrete blocks (ACB) consists of concrete interlocking blocks that are cabled together to form mats that can be laid on the channel slope and/or channel bottom. The ACB is extended below the invert to form a cutoff wall.

ACBs are available in two styles: open cell and closed cell. The open cell style allows for vegetation to be recruited into the soil filling of the cell. Vegetation growth is restricted by the sizes of the cell openings and by the disconnection caused by the cell walls.

Design Criteria:

Appropriate for slopes 0.75:1 up to 3:1.

Appropriate for velocities up to 15 feet per second for closed cell ACBs, 6 feet per second for open cell ACBs.

Habitat Impact Assessment:

Channel bottom:	Permanent impact
Bank:	Permanent Impact

Mitigation: Off-site as specified in Table 10-6 and the SMP permits.

Attachment A – Bank Stabilization Methods
#9: Articulated Concrete Blocks (ACB)

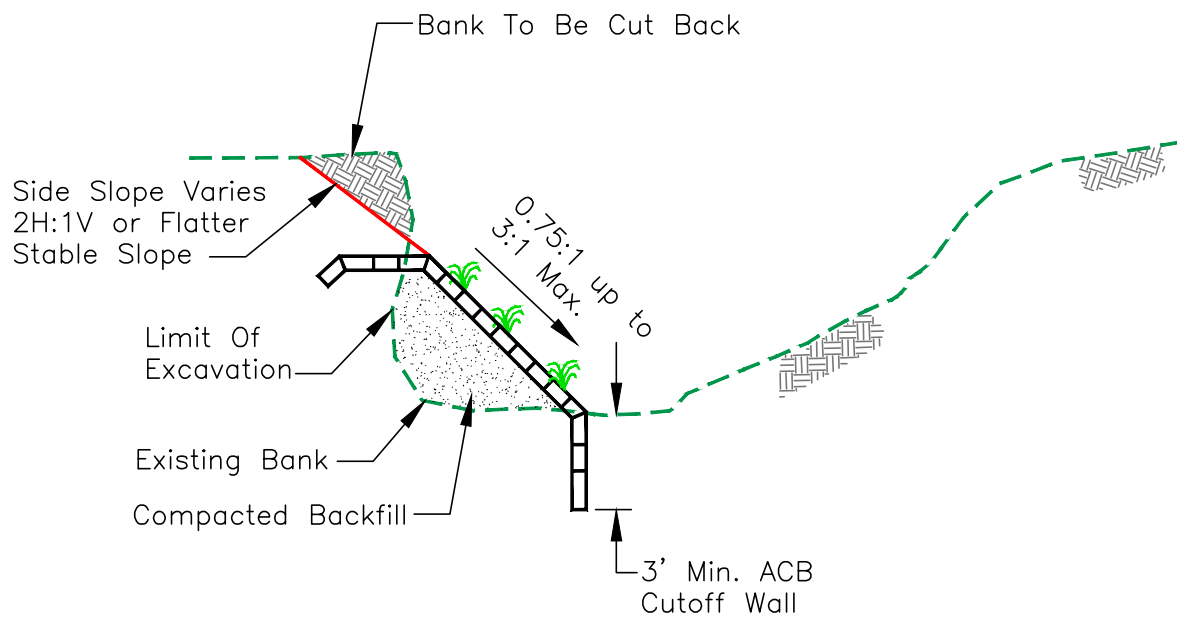

SECTION

Attachment A - Bank Stabilization Methods

#9A: Articulated Concrete Blocks with Planting Areas

Description:

Articulated concrete blocks (ACB) consists of concrete interlocking blocks that are cabled together to form mats that can be laid on the channel slope and/or channel bottom. The ACB is extended below the invert as a cutoff wall to prevent undermining of slope protection.

ACBs are available in two styles: open cell and closed cell. The open cell style allows for vegetation to be recruited into the soil filling of the cell. Vegetation growth is restricted by the sizes of the cell openings and by the disconnection caused by the cell walls.

Open planting areas can be constructed into the ACB mats by creating an opening in the mat by removing some of the blocks. The open areas can be revegetated with shrubs and trees. Irrigation is provided to the planted vegetation to aid plant establishment.

Design Criteria:

Appropriate for slopes up to 1:1.

Appropriate for velocities up to 15 feet per second for closed cell ACBs, 6 feet per second for open cell ACBs.

A typical planting plan is illustrated in Figure 10-10 of the Program Manual. Plantings will be installed as follows: Plant palette will be based on an evaluation of vegetation communities up and down stream of the repair site. A mix of tree, shrub, and herbaceous species will be selected as appropriate from the SMP Table 10-7. Grass species utilized will be SCVWD Erosion Control Mix per Table 10-7. An as-built planting plan diagram (to scale) and plant list will be provided to the permitting agencies.

Herbaceous species:	4 feet average on-center
Shrub species:	8 feet average on-center
Tree species:	12 feet average on-center
Live Stakes/Cuttings:	2 feet average on-center or as log placement allows

Habitat Impact Assessment:

Channel bottom:	Permanent Impact
Bank:	Permanent Impact

Mitigation: Off-site as specified in Table 10-6 and the SMP permits.

Attachment A – Bank Stabilization Methods
#9A: Articulated Concrete Blocks
with Planting Areas

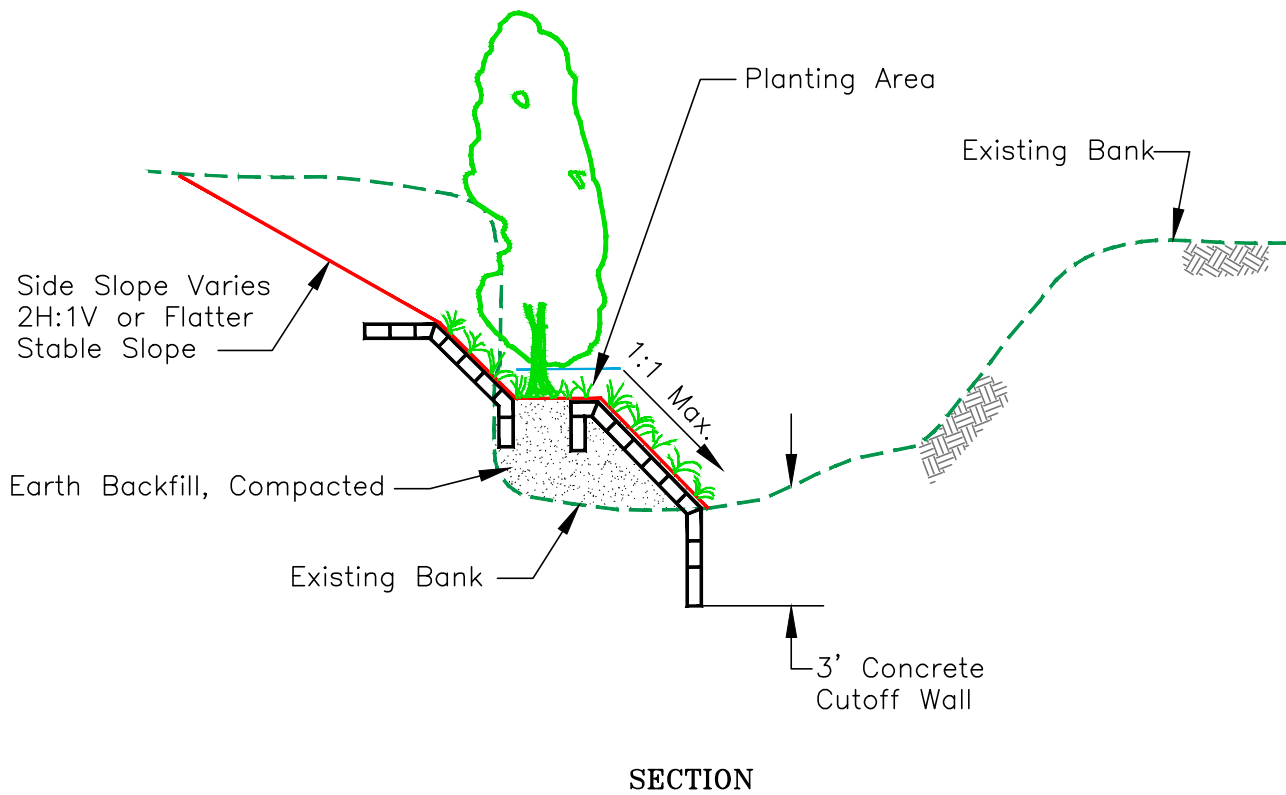

Attachment A - Bank Stabilization Methods

#10: Concrete Crib Walls

Description:

Concrete crib walls consist of stacked interlocking concrete frames that form a retaining wall. The structural strength is developed by the composite design of a concrete frame with compacted backfill. Crib walls are constructed with open face panels that are planted by live staking. This method restricts plant growth by the size of the panel opening. As the crib wall slope is flattened and the lattice becomes more open, the vegetation potential increases and the allowable velocity decreases because of the exposed soil and vegetation.

Design Criteria:

Appropriate for slopes up to 1:1.

Appropriate for velocities from 6 feet per second up to 15 feet per second, depending on the size of the crib wall's openings.

A typical planting plan is illustrated in Figure 10-10 of the Program Manual. Plantings will be installed as follows: Plant palette will be based on an evaluation of vegetation communities up and down stream of the repair site. A mix of tree, shrub, and herbaceous species will be selected as appropriate from the SMP Table 10-7. Grass species utilized will be SCVWD Erosion Control Mix per Table 10-7. An as-built planting plan diagram (to scale) and plant list will be provided to the permitting agencies.

Herbaceous species:	4 feet average on-center
Shrub species:	8 feet average on-center
Tree species:	12 feet average on-center
Live Stakes/Cuttings:	2 feet average on-center or as log placement allows

Habitat Impact Assessment:

Channel bottom:	Permanent impact
Bank:	Permanent Impact

Mitigation: Off-site as specified in Table 10-6 and the SMP permits.

Attachment A – Bank Stabilization Methods
#10: Concrete Crib Walls

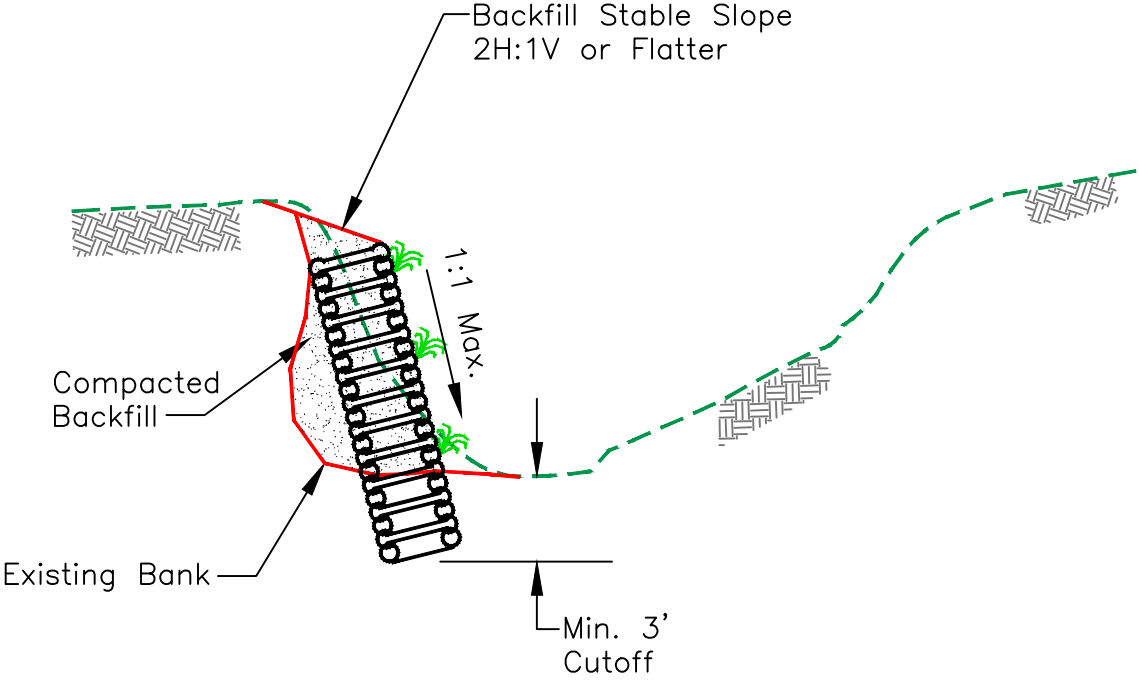

SECTION

Attachment A - Bank Stabilization Methods

#11: Sacked Concrete

Description:

Sacked concrete slope protection (SCSP) consists of burlap bags filled with concrete and placed against channel banks. SCSP requires a three-foot deep concrete or SCSP cutoff wall at the base of the slope to prevent failure. SCSP does not provide any revegetation potential. However, it offers the opportunity to contour walls such that impacts to existing vegetation are avoided

Design Criteria:

Appropriate for slopes up to ½:1.

Appropriate for velocities up to 15 feet per second.

Habitat Impact Assessment:

Channel bottom:	Permanent impact
Bank:	Permanent impact

Mitigation: Off-site as specified in Table 10-6 and the SMP permits.

Attachment A – Bank Stabilization Methods
#11: Sacked Concrete

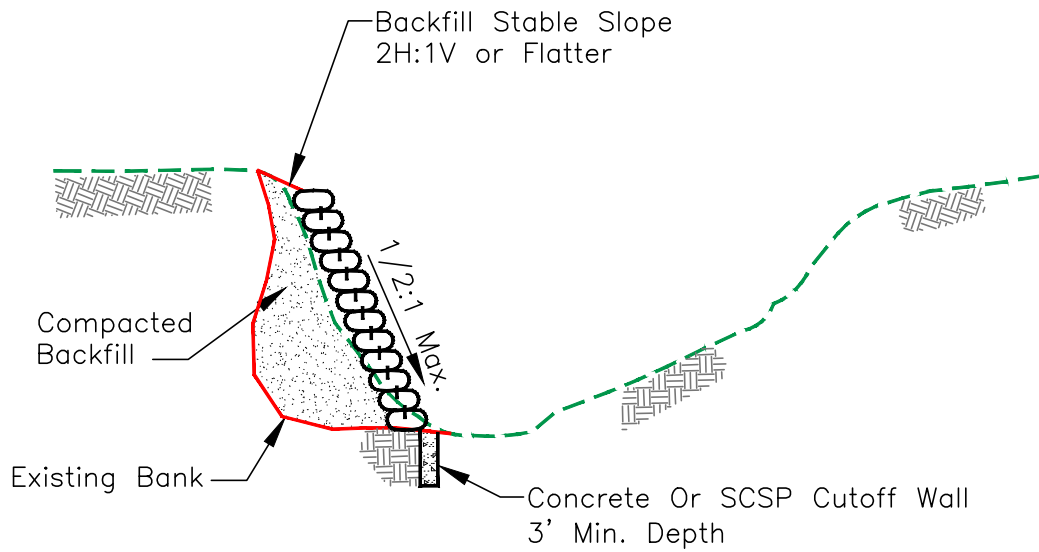

SECTION

Attachment A - Bank Stabilization Methods

#12: Gunite Slope Protection

Description:

Gunite slope protection consists of a concrete mixture sprayed under pressure over an eroded bank. Reinforcing steel may be placed against the bank prior to spraying.

Design Criteria:

Appropriate for slopes up to 0.1:1 (near vertical).

Appropriate for velocities up to 15 feet per second.

Habitat Impact Assessment:

Channel bottom:	Permanent impact
Bank:	Permanent impact

Mitigation: Off-site as specified in Table 10-6 and the SMP permits.

ATTACHMENT B

Fish Relocation Guidelines

	<h1 style="margin: 0;">Fish Relocation Guidelines</h1>	DOCUMENT NO.:	EMAP-W30101
		REVISION:	<i>R1</i>
		EFFECTIVE DATE:	<i>3/18/2010</i>
		PROCESS OWNER:	<i>Louisa Squires</i>
		<i>Page 1 of 8</i>	

Downloaded or printed copies are for reference only. See the District Website for the released version.

1. PURPOSE and SCOPE:

This work instruction is designed to respond to planned and unplanned de-watering events (drybacks) in streams and other water bodies in the jurisdiction of the Santa Clara Valley Water District. The purpose of these efforts is to recover fish and wildlife resources that are at risk during dryback events in order to minimize potential impacts on these natural resources. The primary strategy is to capture organisms (“fish” to include all aquatic species) in areas where water is dried back and relocate them to flowing or standing water. Reconnaissance and operational guidelines for planned and unplanned dryback events are provided in this document.

While these guidelines have been adopted to effectively conduct safe and orderly fish relocations, specific situations may dictate a deviation from these guidelines. As such, each guideline element should be viewed as modifiable to adapt to the immediate circumstances on-site.

2. REFERENCE DOCUMENTS:

Q822F01	Ecological Monitoring & Assessment Program quality Assurance Systems Requirements
EMAP-W20006	Ecological Equipment Checkout Instructions
EMAP-W20007	Disinfection of Biological Equipment
Smith-Root Inc. Model LR-24 and Model 12 Backpack Electrofisher User Manuals	

3. DEFINITIONS:

Unplanned Dryback Operations: Unscheduled events where the flow of water is unintentionally modified by reducing the volume of water in the channel or redirecting flows so that the channel downstream becomes dry. Mobilization for unplanned dryback operations are based on the elements of a planned dryback event.

Planned Dryback Operations: Scheduled events where the flow of water is intentionally modified by reducing the volume of water in the channel or redirecting flows so that the channel downstream becomes dry.

4. REQUIREMENTS:

4.1. ISO 9001

7.5.1 Control of Production and Service Provision

4.2. ISO 14001

4.4.6 Operational Control

4.3. Other Requirements

Board Ends Policy No. E-4 (12/15/09): There is water resources stewardship to protect and enhance watersheds and natural resources and to improve the quality of life in Santa Clara County.

4.1.1.1 Balance the protection and restoration of sensitive fisheries and aquatic species, such as steelhead trout, with a reliable water supply.

Downloaded or printed copies are for reference only. See the District Website for the released version.

5. MONITORING AND MEASUREMENT:

Conduct biennial desk audit of fish relocation activities to ensure that fish relocation activities are documented.

6. PROCEDURE:

<u>Overview</u>	<u>Details</u>	<u>Quality Records</u>
<p>(1) Determine Need for Fish Relocation</p> <p>(Fisheries Biologist)</p>	<ul style="list-style-type: none"> Determine rationale for the rescue and be prepared to communicate this information to other staff and the environmental resource agencies. 	
↓		
<p>(2) Conduct Reconnaissance Survey</p> <p>(Fisheries Biologist)</p>	<p><i>NOTE: A member of the District biological staff with a current scientific collecting permit must be on-site before fish rescues are attempted and resource agency authorization is obtained, unless pre-approval to relocate fish has been granted in a standing agreement (e.g., under the Stream Maintenance Program or other permits).</i></p> <ul style="list-style-type: none"> Upon arrival at the site, District personnel will determine the extent of the dryback and if there will be any immediate or foreseeable impacts to fish and wildlife. Conduct a reconnaissance survey of the dryback zone to establish an operational response. Depending on the species and site, fish and aquatic wildlife may need to be transported to various release sites. Before fish relocation begins, a qualified biologist must identify the most appropriate release location(s). Release locations must have water temperatures within 1° C of the capture location. Release locations must offer ample habitat for released fish, avoid possibility of re-entry to the work area, and avoid areas where individual fish could become impinged on the exclusion net or screen. A variety of elements to be considered in executing a fish resource relocation operation include: 	

Fish Relocation Guidelines

Downloaded or printed copies are for reference only. See the District Website for the released version.

<u>Overview</u>	<u>Details</u>	<u>Quality Records</u>
	<ul style="list-style-type: none"> a) Staging area: Identify staging areas in the dryback zone. Sites should be selected on the basis of proximity and access to the dryback zone and safe operation of the equipment. b) Relocation sites: Priority shall be given to close proximity to the dryback zone within the same stream; if no suitable site within the stream is available, then “second choice” locations within the watershed will be selected. In all cases, the closest site that is likely to result in a successful rescue will be used. c) Transport routes. d) Need for pumping: Determine if pumping activities are necessary and begin as early as possible and timed for optimum relocation activities. e) Downstream vs. Upstream: Species rescued will be transported downstream if possible and upstream only for short distances if downstream sites are not feasible. f) Disease Considerations: Fish will not be moved upstream over substantial barriers or long distances upstream to guard against disease transmission. g) Relocation of anadromous Fish: Salmonid fry and non-smolted juveniles should be moved upstream to a location of perennial running water; smolts should be moved downstream to a location where flow runs continuously to the bay; and adults should be moved according to their spawning condition: unspawned fish upstream to perennial flow; spawned fish downstream where flow runs continuously to the bay. h) Collection and transport methods will be determined per site conditions. Methods will also be selected to maximize efficiency of collection effort while minimizing handling and transport time and stress. Local transport of fish may be executed by various methods including: 	

Fish Relocation Guidelines

Downloaded or printed copies are for reference only. See the District Website for the released version.

<u>Overview</u>	<u>Details</u>	<u>Quality Records</u>
	<ul style="list-style-type: none"> i) Net transfer: Appropriate for short distances where rapid transfer is possible. j) Live car: Appropriate for temporary holding in stream and short distances where rapid transfer is required. a) Bucket: Appropriate for temporary holding and transport over short-medium distances. Holding time should be minimized if possible or supplemental aeration supplied. b) Prioritization of species and collection/relocation sites to be prioritized as follows: <ul style="list-style-type: none"> 1. Endangered species 2. Threatened species 3. Species of special concern 4. Native fishes not under the above categories 5. Non-native fishes if appropriate 	



<p>(3)</p> <p>Notify Resource Agencies</p> <p>(Fisheries Biologist)</p>	<ul style="list-style-type: none"> • Identify a point person to contact appropriate resource agencies (California Department of Fish and Wildlife, National Marine Fisheries Service, U.S. Fish and Wildlife Service). This is typically the collecting permittee. • Notify appropriate environmental resource agencies to communicate the details of the fish relocation and to confirm disposition instructions. Notification is typically done 24 hours in advance when possible. 	
---	--	--



<p>(4)</p> <p>Coordinate Media and Public Relations</p> <p>(Public Information Officer and/or lead Fisheries Biologist)</p>	<ul style="list-style-type: none"> • Contact the District's Public Information Office to serve as a point person for media coverage. As appropriate, PIO staff will develop media information and coordinate appropriate onsite media activities to minimize onsite risk to press and onlookers during operations. • Coordinated media events minimize disruption to operation logistics and timing to maximize safety to participants. Isolation of media activities out of channel is preferred. • For safety, escort media personnel if in-channel or 	
---	---	--

Fish Relocation Guidelines

Downloaded or printed copies are for reference only. See the District Website for the released version.

<u>Overview</u>	<u>Details</u>	<u>Quality Records</u>
	close-proximity events are staged.	
↓		
<p>(5)</p> <p>Plan Operational Logistics (Fisheries Biologist)</p>	<ul style="list-style-type: none"> • Identify and secure all necessary equipment for the fish relocation activities (<i>EMAP-W20006 Ecological Equipment Checkout Instructions</i>) • Arrange multiple transport vehicles to minimize holding time and fish stress. • Contact operational personnel and confirm the degree of mobilization required. • Ensure that mobile communication devices are available in transport vehicles. 	
↓		
<p>(6)</p> <p>Conduct Fish Relocation (Lead Fisheries Biologist and Field Crew)</p>	<ol style="list-style-type: none"> 1. Setup <ul style="list-style-type: none"> • Upon arrival at the site, review the operational sequence and logistics and designate field assignments. Conduct a review of safety and operation methods. Discussion elements may include: site access; local hazards; environmental considerations; media and public safety; equipment operation, etc. 2. Live well Operation <ul style="list-style-type: none"> • If necessary, set up live wells early in the operation in order to stabilize tank conditions. • Use local “native” water to fill live wells if available and clean. • Reduce and manage temperature of live wells as appropriate at 5-10 degrees F to lessen stress in fish. Slightly lower temperature slows metabolism and ammonia production and at the same time will avoid thermal shock. • Start the aeration system prior to placing fish into the live well to ensure that sufficient oxygen is present during the adjustment period. When salmonids are placed in the live well, managed the 	

Fish Relocation Guidelines

Downloaded or printed copies are for reference only. See the District Website for the released version.

	<p>live well to the extent possible so that the dissolved oxygen concentration will be greater than 6 ppm but less than saturation.</p> <ul style="list-style-type: none"> • Salmonids may be transported separately from other fish to reduce stress, handling time, and potential predation in the live well. • To reduce stress in salmonids, at times, a 0.8-0.9 ppt salt solution (never exceeding 1.0 ppt), may be used in the live well to relax the osmotic stress and better manage crowded conditions. This treatment will also help rid the fish of fungal and bacterial agents. This will be administered and managed by trained fisheries biologists if deemed necessary. <p>3. Electrofishing Operation</p> <ul style="list-style-type: none"> • Adjust the electrofishing unit settings to the conductivity and temperature of the water. Adjust setting for either varying width (wide to narrow) or varying frequency (high to low) to minimize possible fish injury when these settings elicit proper taxis for fish capture. • Record the settings used and any incidental electrofishing mortalities in the field notebook. If electrofishing mortalities for salmonids and other species listed as threatened or endangered exceed 5% of the total capture, electrofishing activities will be reevaluated and possibly terminated. • Note fish other than salmonids that are mortalities from electrofishing activities as an indicator of possible injury or mortality rate to salmonids and other fish (i.e. Sacramento suckers are more susceptible to electrofishing injury and mortality than other species and give an ancillary indication of electrofishing success). <p>4. General Collection Guidelines</p> <ul style="list-style-type: none"> • Execute collection of fish in a manner to minimize handling time and stress, yet maintain the safety of personnel. • Use multiple buckets and/or live cars to reduce crowding during collection and transfer. 	<p>EMAP-F30001 Field Notebook Form</p>
--	--	--

Fish Relocation Guidelines

Downloaded or printed copies are for reference only. See the District Website for the released version.

	<ul style="list-style-type: none"> • Pre-sort fish as needed for transport. • Equip buckets that hold salmonids until subsequent transfer to a live well with portable aerators. <p>5. Transport</p> <ul style="list-style-type: none"> • Transport fish to minimize holding time and alternately sequenced in tandem with ongoing collection activities. • Only fisheries biologist with appropriate permits will transportation and accompany all transport operations. • Continue normal live well operations during transport. <p>6. Records and Data</p> <ul style="list-style-type: none"> • Inventory fish and record other pertinent data, including species, numbers of each species, disposition, and other data such as fork length, etc. as appropriate. If conditions preclude a complete inventory, at a minimum, document species present, their disposition, and an estimate of their abundance. • Record information on ambient site conditions, including photo documentation at collection and release sites, as appropriate, and other information on collection, handling, and transport. 	
<p>(7) Conduct Demobilization (Fisheries Biologist)</p>	<ul style="list-style-type: none"> • Sterilize equipment according to <i>Disinfection of Biological Equipment</i> (EMAP-W20007). • Conduct an assessment of the fish relocation to identify lessons learned, estimate the number of individual fish and fish species moved and determine the mortality rate. • Prepare a report summarizing the cause of the dryback, the merits of the fish relocation, and the results of the assessment. This report will be kept on file and copies forwarded to the appropriate 	<p>Fish Relocation Report</p>

	<h1>Fish Relocation Guidelines</h1>	DOCUMENT NO.:	EMAP-W30101
		REVISION:	<i>R1</i>
		EFFECTIVE DATE:	<i>3/18/2010</i>
		PROCESS OWNER:	<i>Louisa Squires</i>
			<i>Page 8 of 8</i>

Downloaded or printed copies are for reference only. See the District Website for the released version.

	environmental resource agencies or interested parties.	
--	--	--

7. QUALITY RECORDS:

QUALITY RECORD	Location Kept	Filing Order	Duration Kept	Disposition	Comments
Field Notebook Form	Project File	Date	Permanent	Archive	
Fish Relocation Report	Project File	Date	Permanent	Archive	

8. CHANGE HISTORY:

Date	Revision	Comments
3/18/10	R1	New Release

ATTACHMENT C

Tree Scoring for Removal of Trees and Shrubs 6-12" dbh

Tree Scoring for Removal of Trees and Shrubs 6 - 12” dbh

Trees and shrubs 6 to 12” dbh may be removed under the Stream Maintenance Program 2014-2023. The sum value from the assessment of four (4) attributes will provide a mitigation ratio for the trees/shrubs proposed for removal. Trees >12” dbh are not included as a part of this removal program. High scores equate to higher value trees, with greater potential impacts if they are removed; and therefore, will require more mitigation. Low scores equate to lower value trees, having fewer potential impacts if they are removed; and therefore, require lower mitigation.

Multi-stem: A tree or shrub with a root ball and multiple trunks or stems. This may occur at ground level or several feet above ground. The dbh of trees with multiple stems will be calculated by adding the diameters of the individual stems at 4.5 feet above ground. Individuals with greater than seven (7) stems at dbh will be assessed by their canopy cover.

A. Approach

Tree replacement would start with a baseline ratio of 1:1. Replacement ratios would increase or decrease based on specific ecological attributes of the individual(s) to be removed and the setting in which it is/they are located. Scoring would add to or subtract from the baseline ratio. Final ratios would be calculated using the methodology outlined below. Non-native species may result in a mitigation ratio of 1:1. While they may be ecological undesirable, they may also provide best available habitat in site specific locations. Native trees will have a minimum 2:1 mitigation ratio. Due to the habitat value of native oaks and sycamores, these species will be replaced in-kind, with like native species.

B. Ranking

1. Canopy cover

- a) Square footage of canopy is measured at the widest drip-line extension of the subject tree.
- b) Grouping or stands of trees are calculated as the summation of each individual tree canopy, even if the canopies overlap. Open space between the trees would not be factored into the square footage calculation.
- c) Calculations may be made on approximations (+/- 5 feet) with areas converted to measurable geometry. Width x length = square footage. (Estimating by a triangle or circle is also acceptable.)
- d) 0-100 sq. ft. is ranked 0 as the baseline from which mitigation starts is 1:1

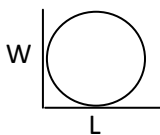

Metric: Choose 1. Assess at widest dripline extension point.

Attribute	Score
0-100 Square Feet of Canopy (< 10’ diameter)	0 points
101-400 Square Feet of Canopy (10 - 20’ diameter)	+ 1 points
>401 Square Feet (> 20’ diameter)	+ 2 points

0-2 points

2. Local Area Value

- a) Is the affected vegetation unique to its geographic location based on a measurable attribute (species, size, structure, absence of adjacent comparable vegetation).
- b) There is a 2000 sq ft maximum for removal of a stand of trees.

Metric: Choose all that apply. Score = 0 if none of these apply.

Attribute	Score
Native Species	+1 point
No similar vegetation within 500 feet radius (Size of canopy, height, or similar measurable criteria; even if non-native).	+1 point
Stand Reduction (Removal of target trees would reduce stand by more than...)	+1 point for 20-50% reduction +2 points for greater than 50% reduction

0-4 points

3. Ecosystem Benefits (wildlife, fisheries, streams)

- a) Tree used by wildlife. Examples include: cavity nesting, nectar feeders, high wildlife food value (seeds, fruits, flowers), cavities and crevices for bats, dead wood for woodpeckers and insect feeders, perching, roosting, nesting, etc. This will rarely ever be zero. Supports macroinvertebrate and biomass decomposition processes.
- b) Provides structure/cover : Nurse tree, horizontal or vertical cover.
- c) Provides SRA: Shaded Riverine Aquatic, ≤ 15 ft from the water’s edge or overhangs water, shade, roots or branches in water providing habitat for fish and aquatic organisms, could contribute instream woody debris.
- d) Tree is 6-12” dbh, provides more mature structure and life form to the surrounding environment.

Metric: Choose all that apply.

Attribute	Score
Used by wildlife	+ 1 point
Structure/Cover (vertical, horizontal)	+ 1 point
SRA	+ 1 point
Tree is 6-12” dbh (life form)	+ 1 point

1-4 points

4. Ecosystem Detriments

- a) Tree has ecologically undesirable attributes.
- b) Ecological arboriculture would include a tree failing to thrive with little or no hope of recovery. Note: this distinguishes between tree removals that may benefit the ecological setting versus hazard trees.

Metric: Choose all that apply. Score = 0 if none of these apply.

Attribute	Score
Significant structural defects	-1 point
Non-native species OR Invasive species	-1 point OR -2 points
Removal for ecological arboricultural reasons (diseased, infestation), excludes hazard trees	-1 point

-4-0 points

C. Mitigation Calculation

Baseline is 1:1 ratio for trees impacted in this size class.

Point reductions could result in a final score that reduces the ratio to less than 1:1.

Due to the habitat value of native oaks and sycamores, these species will be replaced in-kind, with like native species.

Attributes	Min.	Max.
Vegetation Cover	0	2
Local Area Value	0	4
Ecosystems Benefits	1	4
Ecosystems Detriments	-4	0
Total Range	-3	10

Attribute Range	Mitigation Ratio in sq. ft.
-3 - 2	1:1
3 - 5	2:1
6 - 10	3:1

Tree Scoring for Removal of Trees and Shrubs 6 - 12" dbh

Site Location _____
 Assessors Name _____
 Date _____
 ESU # _____

Species _____
 DBH _____
 Canopy Cover sq ft _____
 Reason for Removal _____

1. Canopy cover

Metric: Choose 1. Assess at widest dripline extension point.

Attribute	Score
0-100 Square Feet of canopy cover (< 10' diameter)	0 points
101-400 Square Feet of canopy cover (10-20' diameter)	+ 1 points
>401 Square Feet (> 20' diameter)	+ 2 points

0-2

Vegetation Cover
 Score: _____

Stand maximum = 2000 sq ft

2. Local Area Value

Metric: Choose all that apply. Score = 0 if none of these apply.

Attribute	Score
Native Species	+1 point
No similar vegetation within 500 feet radius (Size of canopy, height, or similar measurable criteria; even if non-native).	+1 point
Stand Reduction (Removal of target trees would reduce stand by more than:.....)	+1 point for 20-50% reduction +2 points for greater than 50% reduction

0-4

Local Area Value
 Score: _____

3. Ecosystem Benefits (wildlife, fisheries, streams)

Metric: Choose all that apply.

Attribute	Score
Used by wildlife	+ 1 point
Structure/Cover (vertical, horizontal)	+ 1 point
SRA	+ 1 point
Tree is 6-12" dbh (life form)	+ 1 point

1-4

Ecosystem Benefit
 Score: _____

4. Ecosystem Detriments

Metric: Choose all rows that apply. Score = 0 if none of these apply.

Attribute	Score
Significant structural defects	-1 point
Non-native species or Invasive species	-1 point or -2 points
Removal for ecological arboricultural reasons (diseased, infestation) excludes Hazard trees	-1 point

-4 - 0

Ecosystem Detriment
 Score: _____

C. Mitigation Calculation

Due to the habitat value of native oaks and sycamores, these species will be replaced in-kind, with like native species.

Attributes	min	max
Vegetation Cover	0	2
Local Area Value	0	4
Ecosystems Benefits	1	4
Ecosystems Detriments	-4	0
Total Range	-3	10

Total 4 Attributes
Score: _____

Attribute Range	Mitigation Ratio
-3 - 2	1:1
3 - 5	2:1
6 - 10	3:1

Mitigation Ratio: _____

Canopy Cover sq ft X Ratio quotient = Amount Owed

ATTACHMENT D

Invasive Plant Removal Program

Invasive Plant Management Plan

1.0 PLAN OVERVIEW

Controlling the spread of invasive plant species is a critical element in improving the ecological health of our streams and watersheds. Invasive plants tend to thrive and spread aggressively, negatively altering resource allocation regimes, wildlife patterns, soil stability and water quality thus degrading habitat quality and the overall ecological value of a site. In addition, invasive plants can exacerbate flooding and fire danger, undermine structural assets, and obstruct access to roads, levees and trails.

The Invasive Plant Management Program (IPMP) will serve as compensatory mitigation for SMP (Stream Maintenance Program) vegetation impacts to upland, riparian, freshwater and tidal wetlands by eliminating or significantly controlling the population of invasive plant species from these affected habitats. The IPMP will be a two-pronged approach including: 1) a systematic program to control priority invasive plants throughout Santa Clara County; and 2) an opportunistic program to manage invasive plants within active individual SMP work sites. These two approaches will dovetail together to enhance the overall ecological health of our creeks and watersheds.

The IPMP may be implemented in any location within the coverage area of the SMP. Priority, however, will be given to conducting control work in locations that contain sensitive habitats, sensitive species and/or provide quality habitat for a variety of wildlife. When possible, the SCVWD/District will coordinate with adjacent landowners to try and accomplish a complementary and consistent approach to invasive plant management.

2.0 PLAN GOALS AND MITIGATION COMMITMENTS

The overall goal of the IPMP is to preserve and improve habitat within Santa Clara County streams and riparian corridors through removal of invasive plants. This will be achieved through early detection and systematic removal of invasive plants in existing high quality habitats, opportunistic removal of invasive plants in SMP work locations, as well as undertaking control efforts in currently degraded habitats to improve the overall ecological site condition.

- A. Over the course of the 10 year permit, the systematic portion of the IPMP will target:
 - 1) removal of priority invasive plants in existing high quality habitats and 2) control efforts in currently degraded habitats to improve overall ecological site conditions. Mitigation needs and credit will be determined annually, dependent on the proposed work for the year. A proposal for mitigation credit and the associated acreage to be treated for this program will be submitted with the "Notice of Proposed Work" (NPW).

- B. The opportunistic portion of the IPMP will target removal of invasive plants at specific SMP work sites. This effort will be variable each year dependent on the number of project sites where invasive plant removal is feasible. Mitigation credit accrued will be used to compensate for on-site vegetation impacts for on-going vegetation maintenance activities,

or sediment removal. Proposed mitigation credit for each project site will be submitted with the annual Notice of Proposed Work.

The IPMP plans to coordinate and collaborate with other regional control and early detection programs in order to stay apprised of regional issues (e.g., Bay Area Early Detection Network (BAEDN), California Invasive Plant Council (CAL-IPC), San Francisco Estuary Invasive Spartina Program (ISP), Arundo Del Norte, etc.). Coordination will also take place with other landowners in Santa Clara County to try and accomplish a complementary and consistent approach to invasive plant management throughout the County (ex., Don Edwards National Wildlife Refuge, Cities of Palo Alto, Mountain View and San Jose, etc.).

3.0 PLAN IMPLEMENTATION

A. Systematic Component

A priority matrix of invasive plant species has been developed which integrates and weights a variety of factors including: the 2006 CAL-IPC ratings, the anticipated rate of spread without management intervention, the feasibility of effective control, impacts to fish and wildlife, impacts to sensitive plant communities, increases in flood or fire danger, and aggressive growth patterns known to cause structural damage to flood control facilities or impede maintenance access (Table 1).

California Department of Food and Agriculture (CDFA), CAL-IPC, and BAEDN invasive plant databases will be consulted periodically to ensure the SCVWD's species list is up to date. Any revisions to Table 1 will be submitted to the agencies for approval. Specific locations targeted for control activities will be selected based on the baseline inventory (See Section 4 below) as well as a variety of other factors including: quality of habitat, feasibility of control, access constraints, etc. Integrated Vegetation Management techniques will be employed (ex., mechanical, chemical, combination, etc.) to utilize the most effective method for each species while providing the greatest amount of protection to environmental resources.

Success criteria will be developed for each site, and/or for each individual target species. Eradication will be the ultimate goal for defined sites where conditions exist to make it a realistic goal. Exclusion or containment strategies may be used where an invasive poses a threat to a sensitive species or habitat type and complete eradication is deemed infeasible. These control strategies may also be used to suppress highly competitive invasive species and give existing native species the ability to thrive.

Control work for certain species may require only 1 - 2 years of treatment to be. Some species require greater effort to achieve effective eradication or containment. Therefore management of these species will result in greater mitigation credit. Table 1 divides the invasive species list into two tiers based on the level of effort required for effective management. Species in the "Tier 1" category will result in a mitigation credit of 1:1 (mitigation area credited:impact area). Species needing 3 years or more of treatment are in the "Tier 2" category and will result in a mitigation credit of 2:1. "Tier 2" provides mitigation at a ratio of 2:1 to recognize the additional resources needed to be successful, difficulty in managing/eradicating the species, and benefits

provided to the site ecology. Invasive species removed for the purposes of flow conveyance, a sediment removal project, or bank stabilization project will be considered neutral, requiring neither mitigation credit nor debt (mitigation ratio is 0:1). The proposed mitigation ratio will be included in the NPW.

Efforts will be made to encourage natural revegetation/recruitment at treatment sites, including suppression of other weed species. In areas where revegetation does not occur naturally within 1-2 years, a biological/horticultural assessment will be made to determine what impediments may exist to natural revegetation. In areas where revegetation potential exists, a plan will be developed to install site-appropriate vegetation. Mitigation credits for revegetation may be applied, consistent with SMP-2 mitigation accounting.

IPMP may be combined with other forms of mitigation such as revegetation or land acquisition to encourage a holistic mitigation program that is sustainable in the long term.

B. Opportunistic Component

Invasive plant species are frequently found during field inspections and are often associated with other identified SMP work activities (i.e., vegetation management, sediment removal, minor maintenance). In these instances, opportunistic control of invasive plants may enhance habitat quality and benefit the ecological landscape. Invasive species removed for the purposes of flow conveyance, a sediment removal project, or bank stabilization project will be considered neutral, requiring neither mitigation credit nor debt.

There is no specific target acreage for the opportunistic component of the Program. Credit for these removals will be on a case by case/ site by site basis. Proposed mitigation credit for each project site will be submitted with the annual Notice of Proposed Work.

C. Coordination & Education

The SCVWD will coordinate and collaborate with other regional control and early detection programs in order to stay apprised of regional issues (e.g., BAEDN, CAL-IPC, ISP, Arundo Del Norte, etc.). The IPMP will document invasive species occurrence and control data and submit pertinent information to regional databases (e.g., CAL-IPC, Cal Flora, and BAEDN).

Coordination will also take place with other landowners in Santa Clara County to try and accomplish a complementary and consistent approach to invasive plant management throughout the County (ex., Don Edwards National Wildlife Refuge, Cities of Palo Alto, Mountain View and San Jose, etc.).

An informational brochure highlighting priority invasive species will be published which includes pictures, provides descriptions, and discusses the threats posed by each plant to help educate SCVWD field staff and the public about these species. Increased awareness will aid with early detection and/or identification of previously unidentified locations of these species. In addition, during control activities, informational postings will be placed at publicly accessible sites.

4.0 MONITORING

A. Baseline Inventory and Database Development

The county-wide vegetation mapping conducted in 2010 by Aerial Information Systems, Inc. (AIS) for the SMP will be used to develop a baseline inventory of invasive species in the SMP footprint. This data layer will be supplemented with pertinent information collected by SCVWD staff and regional databases (e.g., CAL-IPC, Cal Flora, etc.) to establish the Year 1 baseline inventory.

The inventory will be updated annually based on field inspection data collected by Vegetation Management staff, biologists, and Field Operations Administrators. Over the life of the program, important information will be collected regarding the distribution of invasive species in Santa Clara County watersheds, their overall ecological impact, the efficacy of management efforts, and the best direction for future management to reduce the negative ecological impacts of invasive plants.

B. Treatment Monitoring

Treatment areas will be mapped with a GPS and tracked for long-term success at all programmatic and opportunistic control sites. This will help determine the efficacy of the particular treatment and determine if additional control work and/or a different technique will be necessary. Results of the treatment monitoring will be critical for prioritizing follow-up treatments and planning seasonal work. Tier 1 (from Table 1) will be monitored in years 1 and 3. Tier 2 will be monitored in years 1, 3, and 5.

5.0 REPORTING

The NPW will include a discussion of the mitigation details of both the systematic and opportunistic components of the IPMP. Acreage of target species to be controlled as well as general locations of control activities will be discussed.

Annual summary reports will be submitted to the regulatory agencies providing details regarding the species treated, control methods used, and locations of treatment work. Tier 1 (from Table 1) will be reported in years 1 and 3. Tier 2 will be reported in years 1, 3, and 5.

Recommendations will be provided, including future management needs and the feasibility of active revegetation, if necessary.

6.0 SCHEDULE

The IPMP will be implemented over the course of the 10 year permit. Specific project milestones include:

- Regional coordination will be ongoing upon initiation of the program.
- Baseline invasive plant inventory will be completed within the first two years of the program.
- Priority matrix of invasive plant species will be updated as needed.
- Proposal for mitigation credit will be submitted annually with the Notice of Proposed Work.
- Control efforts for the opportunistic component will begin in year 1 of the program.

- Control efforts for the programmatic component will begin in Year 2 after the baseline inventory is complete.
- Mitigation status will be reported annually.

7.0 PLAN ADMINISTRATION

This program has been constructed for the sole purpose of meeting the mitigation requirements of the SMP.

As a mitigation element of the SMP, the IPMP is defined as a separate work category. While it has elements of vegetation management, revegetation and maintenance it is not subject to the limitations defined for these separate work activities to the extent that these activities are performed as mitigation. As described elsewhere in the SMP Manual, IPMP will only be conducted up to the optimal level to maximize ecological values at a site; removal beyond that for other purposes (e.g., flood conveyance) would be considered an impact requiring mitigation, and would be subject to applicable Program limits. Since the IPMP is a mitigation element, the IPMP will have a higher level of biological oversight and resource protection than other “impact” program components.

Table 1. Invasive Plant List

Species	Common Name	Habitat	Life Form	Systematic Program Mitigation Ratios
Species with 1-2 years of control work (TIER 1)				
Casuarina cunninghamiana	river she-oak, beefwood	Riparian & upland	tree	1:1
Cotoneaster spp.	cotoneaster	Riparian & upland	tree	1:1
Eucalyptus spp.	eucalyptus, gum	Riparian & upland	tree	1:1
Fraxinus spp.	ash	Riparian & upland	tree	1:1
Juglans spp. (J. regia, J. californica)	walnut	Riparian & upland	tree	1:1
Ligustrum spp.	privets	Riparian & upland	tree/shrub	1:1
Nicotiana glauca	tree tobacco	Upland & ruderal (levees)	tree/shrub	1:1
Olea europaea	olive	Riparian & upland	tree	1:1
Palm Spp. (Phoenix canariensis, Washingtonia robusta)	palms	Riparian & upland	tree	1:1
Populus nigra 'Italica'	Lombardy poplar	Riparian & upland	tree	1:1
Rhamnus alaternus	Italian buckthorn	Riparian & upland	tree/shrub	1:1
Schinus molle	Peruvian pepper tree	Riparian & upland	tree	1:1
Sesbania punicea	red sesbania, rattlebox	Riparian & upland	perennial herbaceous	1:1

Species	Common Name	Habitat	Life Form	Systematic Program Mitigation Ratios
Species with 3 years or more of control work (Tier 2)				
Acacia spp.	acacia	Riparian & upland	tree	2:1
Ailanthus altissima	tree of heaven	Riparian & upland	tree	2:1
Arundo donax	giant reed	Riparian & upland	perennial grass	2:1
Broom spp.	Broom species	Riparian & upland	shrub	2:1
Centaurea solstitialis	star thistle	Upland & ruderal (levees)	annual herbaceous	2:1
Conium maculatum	poison hemlock	Upland & ruderal (levees)	annual/biennial	2:1
Cortaderia spp.	pampas grass, jubata grass	Upland & ruderal (levees)	perennial grass	2:1
Cynara cardunculus	artichoke thistle	Tidal & FW marsh & ruderal	perennial herbaceous	2:1
Delairea odoata	Cape Ivy	Riparian & upland	vine	2:1
Ditrichia graveolens	stinkweed	Upland & ruderal (levees)	annual herbaceous	2:1
Foeniculum vulgare	fennel	Riparian & upland	perennial herbaceous	2:1
Hedera spp.	English ivy, Algerian ivy	Riparian & upland	vine	2:1
Lepidium latifolium	pepperweed	Tidal & FW marsh & ruderal	perennial herbaceous	2:1
Myriophyllum aquaticum + spicatum	parrotfeather	Aquatic	aquatic	2:1
Phalaris aquatica	Harding grass	Riparian & upland	perennial grass	2:1
Phragmites australis	common reed	Tidal and FW marsh	perennial grass	2:1
Quercus ilex	holly oak	Riparian & upland	tree/shrub	2:1
Ricinus communis	castor bean	Upland & ruderal (levees)	annual, biennial	2:1
Robinia pseudoacacia	black locust	Riparian & upland	tree	2:1
Rubus armeniacus	himalayan blackberry	Riparian	vine	2:1
Salix babylonica (and hybrids)	weeping willow	Riparian	tree	2:1
Spartina alterniflora	atlantic cordgrass	Tidal marsh	perennial grass	2:1
Tamarix ramosissima	salt cedar	Riparian & upland	tree/shrub	2:1
Ulmus spp.	elm	Riparian & upland	tree	2:1
Vinca major	vinca, periwinkle	Riparian & upland	perennial herbaceous	2:1

ATTACHMENT E

Large Woody Debris (LWD)
Mitigation Accounting Criteria

Management of Large Woody Debris in Santa Clara County Streams

Guidelines for Implementation

Objective

Retain woody debris in streams throughout Santa Clara County in order to preserve the physical and biological processes associated with the natural recruitment of wood to waterways. This is the process of altering urban streams so that their behavior corresponds as closely as possible with that of natural streams while providing some measure of flood protection (Keller and Hoffman, 1977).

Location, Size and Description of Large Woody Debris

These guidelines pertain to the instream area which is defined as the stream channel within bankfull discharge demarcations. Bankfull is the river elevation (stage) at which time the most effective geomorphic work occurs. This is also referred to as the dominant discharge and is the stage that generally corresponds to a flow event with a 1-2 year recurrence interval. See Figure 1. Furthermore, these guidelines will utilize established methods of defining and classifying large woody debris (LWD) as outlined in California Salmonid Stream Habitat Restoration Manual (CDFG, 1998).

While LWD management occurs throughout the County, this management process is required for the following channels:

Central California Coast Steelhead Distribution in the Project Area

Creek/River	Upper Limit Of Steelhead Distribution
Alamitos Creek	Almaden Dam
Arroyo Aguague ¹	Falls upstream from confluence with Upper Penitencia Creek
Calero Creek	Calero Dam
Coyote Creek	Leroy Anderson Dam
Guadalupe River/Creek	Guadalupe Dam
Los Gatos Creek	Camden Avenue Drop Structure
Los Trancos Creek ¹	Approximately 0.4 mile north of headwaters
San Francisquito Creek	Searsville Dam
Stevens Creek	Stevens Creek Dam
Upper Penitencia Creek	Cherry Flat Reservoir

South-Central California Coast Steelhead Distribution in the Project Area

Creek/River	Upper Limit Of Steelhead Distribution
Bodfish Creek	Bodfish Creek Falls
Cedar Creek ¹	Approximately 3 miles north of Cedar Creek Boulder Falls #2
Little Arthur Creek ¹	Cement Dam (near Redwood Retreat Road crossing)
Llagas Creek	Chesbro Reservoir Dam

Pacheco Creek ¹	North Fork Dam
Pajaro River	Steelhead occur in all portions of the creek within Santa Clara County
Pescadero Creek ¹	Creek source
Tar Creek ¹	Southern end of Castro Valley approximately 1.8 river miles from source
Uvas/Carnadero Creek	Uvas Dam
South Fork Pacheco Creek ¹	South Fork Pacheco Creek Boulder Falls

¹ Although work is not expected on these creeks, they are within the SMP project area and are therefore included here.

During the initial biological survey of the woody debris site, the biologist will be responsible for recording the size and position of the wood in relation to the channel. Large woody debris is defined as having a minimum diameter of 12 inches (30.5 cm) with a minimum length of 6 feet (1.82 meters). Management of the area beyond the instream zone, the recruitment zone, which encompasses the floodplain, is not incorporated in these guidelines.

Management Strategy

In order to effectively manage large woody debris in streams within the urban landscape of Santa Clara County, the District will use a four tiered, multi-disciplined approach. To address the range of issues that LWD can pose in a channel, the assessment of LWD will be performed by an engineer, biologist and field operations administrator. The four tiered, multi-disciplined approach is described below, though minor modifications may occur based on individual site conditions. Mitigation is only required for Tier 4) Remove LWD.

Tier 1) Retain LWD in the Channel

Watershed maintenance crews will identify sites in which large woody debris is proposed for removal. Each site will be evaluated by a biologist to determine the ecological and geomorphic integrity the wood is providing to the stream channel. During the biological evaluation the size and position of the wood in relation to the wetted channel should be described. Additionally, a GPS point or GIS coordinates of the wood should be recorded regardless of the fact that the wood may eventually be removed. Watershed engineers may be asked to evaluate the woody debris to determine the potential for bank erosion, channel incision or infrastructure safety. If a consensus is reached to leave the wood in place, the watershed personnel may collectively decide if the woody debris will require additional monitoring.

Tier 2) Modify In-Channel LWD

If the LWD cannot be left in its original configuration and position within the wetted channel due to flooding, trash or erosion potential, the wood can be modified and left in place. Modification can include: removal of small, lateral branches which capture debris; changing position of the LWD to avoid excessive bank scour; reconfiguration of the LWD to avoid aggradations or channel incision in select locations; or cutting of the wood into smaller pieces, all of which must

be larger than the LWD definition of 1' diameter by 6' in length. Lateral limbs < 12" dbh may be removed. Lateral limbs larger than 12" dbh and 1' long would be considered additional large woody debris. The most important consideration in the decision making process to modify the LWD, is to retain its biological and geomorphic integrity. If that is not a feasible option, watershed staff should consider removal or remove/replace alternatives (Tiers 4 and 3).

Tier 3) Remove LWD and Replace

If the watershed staff decide the wood is an imminent flood risk or infrastructure safety is of great concern, the third tier in the decision making process is to remove the wood from its original location and replace it elsewhere within the watershed. Considerations for the new location of wood placement would be the presence of a floodplain, larger width/depth ratio, greater biological value (i.e. natural channel versus modified), or simply improved access.

Tier 4) Remove LWD

If all other avenues of wood management are exhausted, Tiers 1-3, watershed staff may decide that the wood requires complete removal from the stream channel. Complete removal may occur in highly modified streams with low or zero tolerance for instream vegetation or structures such as LWD. Cutting LWD into smaller pieces and leaving it within the channel is also considered to be removal, as the habitat values have been lost.

The removal of Tier 4 LWD from anadromous salmonid channels will be mitigated by installing LWD instream complexity features at a ratio of 1:1 (mitigation to impact) for the habitat function. Mitigation may be provided on-site or be "pooled" into the single user mitigation bank prior to or within a year from the removal of LWD.

Monitoring LWD

The selection of when and what to monitor will be derived from any concerns that arose during the decision making process (Tiers 1-2) to leave the wood in place. For example, if the potential for bank scour was cited as a chance of occurrence, the team may decide to install lateral scour bars into the bank. Painted rebar will be installed laterally into the stream bank at selected locations to determine if local scour occurs due to the presence of the wood in the channel. If excessive aggradations or channel incision is a concern for watershed staff, then scour chains can be installed in appropriate locations. The biologist will be responsible for installation of the agreed upon monitoring tools (i.e. lateral scour bars, scour chains) and installation of the tree tag.

Monitoring of Tier 4 LWD will be performed to determine how the success criteria for that specific site are being met, as described in the NPW. Monitoring of Tier 3 LWD will be performed for reporting purposes only, to obtain additional information about the placement and movement of wood. These will be reported in the ASR. Monitoring will occur in years 1, 3, and 5 post construction. Tiers 3 – 4 will be fitted with an aluminum tree tag and given a unique identifying number. The purpose of monitoring is to better understand the response of the channel to LWD placement under a range of flow conditions and identify if improvements in

LWD placement can be achieved. This information will assist in guiding the type of placement of future LWD.

Monitoring will occur after relatively high flow events (as possible) to determine if the objective of the wood installation is met or if it is creating any adverse effects in the channel. Other treatments can be considered if additional erosion protection is required. Lateral scour bars may be installed if bank erosion is an issue.

LWD is a naturally active resource within streams and channels. Movement of LWD is anticipated and often desired. The success criteria for placement of the LWD will largely depend on the objective of the installation. The objective and measurable criteria will be included in the NPW. Additionally, successful placement of wood should not induce any adverse effects to the stream channel including accelerated erosion or deposition, physical structure failure or displacement of other ecologically beneficial features (i.e. lateral scour pool, loss of riffle habitat etc.). If the wood has achieved the desired objective for installation as stated in the NPW (i.e. provide cover, provide velocity refuge, induce lateral scour, encourage deposition of spawning gravels) and stayed in place for one year post construction it will be deemed successful, has met the mitigation obligation for removal of wood, and no further actions are required.

An important component to monitoring LWD is to determine the flow rate at which the wood will move. If the wood moves from its original location during a storm event, the biologist will survey downstream locations for the LWD and determine the maximum discharge from the closest upstream gauge. This information can be utilized in future decision making processes to leave/remove LWD within a watershed. Most geomorphic effects of wood in rivers arise from large, stable logs (Montgomery, 2003). Finding the threshold for size and movement will assist the watershed staff in long term management of wood in local urbanized drainages. If the LWD does move from its original location it will have to be reassessed for safety/flooding concerns. Success criteria and objectives for each project will be included in the Notice of Proposed Work.

Database Management

Each request submitted by watershed maintenance staff for biological evaluation of LWD will be tracked in the database management system. The database can track what percentage of wood is left in place within a watershed, what is modified and what is removed. Effectively managing LWD overtime can improve channel processes which will enhance habitat features as well as reduction of trucking and disposal costs of LWD.

Summary of Roles and Responsibilities

- 1) Watershed maintenance staff submits work request for removal of LWD.
- 2) Biologist surveys wood to determine ecological/geomorphic integrity.
- 3) Engineer, maintenance staff, and biologist determine if LWD stays in place. Staff can then determine a course of action based on the four tiered approach.
- 4) If monitoring is required, the biologist assigned to the original evaluation will be in charge of installation of monitoring devices and periodic monitoring.
- 5) The biologist is responsible for entry of all applicable data into the management system.

Literature Cited

CDFG. California Department of Fish and Game. 1998. California Salmonid Stream Habitat Restoration Manual. State of California Resources Agency. Third Edition.

Keller, E.A., and E.K. Hoffman. 1977. Urban streams: sensual blight or amenity. *Journal of Soil and Water Conservation* 32:237-242.

Montgomery, D.R., B.D. Collins and J.M. Buffington. 2003. Geomorphic Effects in Rivers. *American Fisheries Society Symposium* 37: 21-47.

Rosgen, D. 1996. *Applied River Morphology*. Wildland Hydrology, Pagosa Springs, Colorado.

Stream Maintenance Program Renewal Project

Prepared by Watershed Management Division

Melissa Moore

ATTACHMENT F

Best Management Practices

Best Management Practices

A. SECTION A –Pre-Project Planning and General BMPs

General BMPs are applicable program-wide, for most routine SMP maintenance activities. These measures include standard construction practices and impact avoidance measures that will minimize potential environmental impacts. These BMPs will be implemented by the stream maintenance crew, as appropriate and as overseen by site managers, for all activities associated with the maintenance program. The majority of these BMPs are implemented prior to and during maintenance operations, though the level of activity varies depending on the work type.

Other General BMPs are conducted prior to implementing maintenance activities on site. This group of measures includes procedures to identify site or maintenance constraints, such as biological or cultural resource surveys which coincide with permit compliance requirements. Site design constraints for sediment and bank stabilization activities in particular are also identified as part of the pre-project planning process.

BMP Number	BMP Title	BMP Description
GEN-1	In-Channel Work Window	<p>All ground-disturbing maintenance activities (i.e., sediment removal, bank stabilization, tree removal, and mechanized vegetation management) occurring in the channel (below bankfull) will take place between June 15 and October 15. Requests for work window extensions must be submitted to the regulatory agencies by October 1st, listing the creek names and reaches where a work extension will occur. Work extensions vary per work activity. The agencies will provide a single response within one week. Significant rainfall applies after October 15. An extension through December 31 may apply if the following requirements are met and regulatory agency approval is received:</p> <p>For ground-disturbing activities:</p> <ul style="list-style-type: none"> ▪ Work may continue if no significant rainfall, defined as greater than 0.5 inches per 24 hours within a local watershed, is either forecasted¹ or observed. Following October 15th, maintenance work shall cease for the season if such a rain event is forecasted or observed. ▪ In the Pajaro Basin, winterized sites will be visually inspected prior to, and within 48 hours following, each significant rain event (defined as rainfall 0.5 inch or greater within a 24-hour period in the subject watershed) to ensure that winterization measures are properly implemented and maintained. <p>Sediment removal</p> <ul style="list-style-type: none"> ▪ Extended Work Window: <ol style="list-style-type: none"> 1. Creeks supporting anadromous fish: An extended work window may occur from October 15 through October 31, or until local rainfall of 0.5 inches or greater falls within the subject watershed within a 24-hour period, whichever occurs first. 2. Creeks not supporting anadromous fish: An extended work window may occur from October 15 through November 30th, or until local rainfall of 0.5 inches or greater falls within the subject watershed within a 24-hour period, whichever occurs first. ▪ Extended Work Window in Lower Quality Areas:

¹ Weather Forecasts. No phase of the project may be started if that phase and its associated erosion control measures cannot be completed prior to the onset of a storm event if that construction phase may cause the introduction of sediments into the stream. Seventy-two-hour weather forecasts from the National Weather Service or other localized and more detailed weather forecast service will be consulted prior to start up of any phase of the project that may result in sediment runoff to a stream.

BMP Number	BMP Title	BMP Description
		<ol style="list-style-type: none"> 1. Sediment removal work may occur until December 31. 2. Work will only occur on Berryessa Creek (0-88+80; 232+70-236+00; 284+30-288+00), Lower Silver Creek (Reach 3 between Stations 37+40 and 381+19), Thompson Creek (0+00-10+00), Canoas Creek (0+00-390+00), Ross Creek (0+00-86+30), Calabazas Creek (35+00-105+00), and San Tomas Aquino Creek (80+00-100+00) with the following conditions: <ul style="list-style-type: none"> o site conditions are dry and access for all construction equipment and vehicles will not impact waterways; and o all work will stop if any rainfall is forecast for the next 72 hour period. 3. Work may occur after a significant rainfall event but no later than December 31. 4. Sites must be maintained in a rapidly winterizable² state (implement control measures BMP GEN-20). <p>Bank stabilization projects may continue until the approved date stated below. Prior to a forecasted significant rainfall event (0.5 in/24 hrs), all incomplete bank stabilization projects must be winterized.</p> <ol style="list-style-type: none"> 1. In Creeks Supporting Anadromous Fish <ul style="list-style-type: none"> o An extended work window may occur until October 31st for bank stabilization projects that will be 50% complete by October 15th. 2. In Creeks Not Supporting Anadromous Fish <ul style="list-style-type: none"> o An extended work window may occur until November 30th for projects that will be 50% complete by October 15th or until significant rainfall. o An extended work window may occur until November 30th for new bank stabilization projects that will be completed in five (5) days or less, or until significant rainfall. <ul style="list-style-type: none"> ▪ Instream hand pruning and hand removal of vegetation will occur year round, except when: <ul style="list-style-type: none"> o Wheeled or tracked equipment needs to access the site by crossing a creek, ponded area, or secondary channel; or o Work occurs in streams that support steelhead. In these streams instream vegetation maintenance will cease on December 31 or when local rainfall greater than 0.5 inches is predicted within a 24-hour period of planned activities, whichever happens first. <p>Modification and removal of instream large woody debris will occur at any time of the year, and as further described in the NMFS Biological Opinion.</p>
GEN-2	Instream Herbicide Application Work Window	<p>Instream herbicide applications will take place between June 15 and October 15, or until the first occurrence of any of the following conditions; whichever happens first:</p> <ul style="list-style-type: none"> ▪ local rainfall greater than 0.5 inches is forecasted within a 24-hour period from planned application events; or ▪ when steelhead begin upmigrating and spawning in the 14 anadromous steelhead creeks, as determined by a qualified biologist (typically in November/December), <ul style="list-style-type: none"> o A qualified biologist will determine presence/absence of sensitive resources in designated herbicide use areas and develop site-specific control methods (including the use of approved herbicide and surfactants). Proposed herbicide use would be limited to the aquatic formulation of glyphosate (Rodeo or equal). Surfactant use would be limited to non-ionic products, such as Agri-

² Winterization is the process to maintain work sites with the appropriate BMP's to prevent erosion, sediment transport, and protect water quality. Winterization occurs upon completion of bank repairs or on incomplete projects after October 15 and prior to the forecast of significant rainfall, 0.5 inches or greater of local watershed rainfall within 24 hours. Winterization shall be completed prior to the occurrence of such actual significant rainfall.

BMP Number	BMP Title	BMP Description
		<p>dex, Competitor, or another brand name using the same ingredients. Any modifications to these materials would require review and approval by NMFS and CDFW.</p> <ul style="list-style-type: none"> o A qualified fisheries biologist will review proposed herbicide application methods and stream reaches. The fisheries biologist would conduct a pre-construction survey (and any other appropriate data research) to determine whether the proposed herbicide application is consistent with SMP approvals concerning biological resources and determine which BMPs would be instituted for work to proceed. <p>In addition, herbicide application requirements are as follows:</p> <ul style="list-style-type: none"> ▪ no direct application into water; ▪ herbicide application shall not occur when wind conditions may result in drift; ▪ herbicide solution shall be applied only until there is a “wet” appearance on the target plants in order to avoid run off; and ▪ where permitted, surfactants shall be added to the spray solution prior to application.
GEN-3	Avoid Exposing Soils with High Mercury Levels	<p>Sediment removal and bank stabilization projects in portions of the Guadalupe River watershed affected by historic mercury mining may expose soils containing mercury.</p> <ol style="list-style-type: none"> 1. In Basin Plan identified creeks in the Guadalupe River Basin, soils that are likely to be disturbed or excavated shall be tested for mercury (Hg). Soils shall be remediated if disturbed or excavated soils exposed to streamflow have a residual sample test exceeding 0.2 mg mercury per kg erodible sediment (dry wt., median). 2. Remediation may be accomplished either by: <ol style="list-style-type: none"> a. treating the site so that contaminated soils excavated for the purpose of bank stabilization shall not be susceptible to erosion; or b. further excavating contaminated soils and replacing them with clean fill or other bank stabilization materials that are free from contaminants. c. Soils with residual sample mercury concentrations exceeding 0.2 mg mercury per kg erodible sediment (dry wt., median) shall be removed and disposed of in a Class I landfill following established work practices and hazard control measures. Soils with residual sample mercury concentrations less than 0.2 mg mercury per kg erodible sediment (dry wt., median) will remain at the project site. 3. To ensure worker safety during sediment removal and bank stabilization projects with elevated mercury concentrations in the exposed surfaces, personal protective equipment will be required during project construction to maintain exposure below levels established by the Occupational Safety and Health Agency (OSHA).

Biological Resources

GEN-4	Minimize the Area of Disturbance	To minimize impacts to natural resources, soil disturbance will be kept to the minimum footprint necessary to complete the maintenance operation.
GEN-5	Mitten Crab Control Measure	Sediment from the San Francisco Bay Watershed, including that for reuse, cannot be moved to areas any farther south than Coyote Creek Golf Drive in south San Jose, and the intersection of McKean and Casa Loma Roads.
GEN-6	Minimize Impacts to Nesting Birds via Site	<ol style="list-style-type: none"> 1. For activities occurring between January 15 and August 31, project areas will be checked by a qualified biologist or Designated Individuals (DI – for limited ground nesting species surveys) for nesting birds within 2

BMP Number	BMP Title	BMP Description
	Assessments and Avoidance Measures	<p>weeks prior to starting work. If a lapse in project-related work of 2 weeks or longer occurs, another focused survey will be conducted before project work can be reinitiated.</p> <ol style="list-style-type: none"> 2. If nesting birds are found, a buffer will be established around the nest and maintained until the young have fledged. Appropriate buffer widths are 0.5 mile for bald and golden eagles; 250 feet for other raptors and the least Bell's vireo, herons, and egrets; 25 feet for ground-nesting non-raptors; 700 feet for the California clapper rail; 600 feet for the California least tern and western snowy plover; and 50 feet for non-raptors nesting on trees, shrubs and structures. Mowing and weed whacking will have a 25 feet buffer. A qualified biologist may identify an alternative buffer based on a site specific-evaluation. No work within the buffer will occur without written approval from a qualified biologist, for as long as the nest is active. 3. All vegetation management, sediment reuse, road grading, or other SMP activities in or immediately adjacent to suitable California clapper rail or Alameda song sparrow nesting habitat, as determined by a qualified biologist, shall not be conducted prior to September 1 (the non-nesting season). 4. If a pre-activity survey in high-quality San Francisco common yellowthroat breeding habitat (as determined by a qualified biologist) identifies more singing male San Francisco common yellowthroats than active nests, then the inconspicuous nests of this species might have been missed. In that case, maintenance activities in that area shall be delayed until the San Francisco common yellowthroat non-breeding season (i.e., August 16–March 14). 5. The boundary of each buffer zone will be marked with fencing, flagging, or other easily identifiable marking if work will occur immediately outside the buffer zone. 6. All protective buffer zones will be maintained until the nest becomes inactive, as determined by a qualified biologist. 7. If monitoring shows that disturbance to actively nesting birds is occurring, buffer widths will be increased until monitoring shows that disturbance is no longer occurring. If this is not possible, work will cease in the area until young have fledged and the nest is no longer active.
GEN-6.5	Protection of Nesting Least Bell's Vireos	<ol style="list-style-type: none"> 1. To the extent feasible, SMP activities within those areas mapped as vireo habitat in the Santa Clara Valley Habitat Plan shall be scheduled to occur outside of the least Bell's vireo nesting season (March 15 – July 31). If it is not feasible for maintenance activities along these reaches to be scheduled during the non-nesting season, the following measures will be implemented. 2. For activities within woody riparian habitat mapped as vireo habitat in the Santa Clara Valley Habitat Plan that will occur between March 15 and July 31, any work will be preceded by a focused survey for least Bell's vireos. Pre-activity surveys will consist of two site visits, conducted on separate days within 14 days before the initiation of maintenance activities in the given area, with at least one of these surveys occurring within 5 calendar days before the initiation of such activities. Surveys will be conducted between dawn and 11:00 a.m., during mild weather conditions (i.e., not during excessive cold, heat, wind, or rain), within all riparian habitat in and within 250 feet of any proposed maintenance location along these reaches. The surveys will be conducted by a qualified biologist who is familiar with the visual and auditory identification of this species. 3. To minimize impacts to nesting least Bell's vireos and other birds, the biologist will not initially be looking for Bell's vireo nests during these surveys. Rather the biologist will look and listen for individual vireos. If a least Bell's vireo is detected, it will be observed to determine whether it is actively nesting. The biologist will note the nest location, or if finding the actual nest could result in excessive disturbance or risk damaging the nest, the biologist will determine the approximate location, based on observation of birds carrying nesting material,

BMP Number	BMP Title	BMP Description
		<p>carrying food, or repeatedly visiting a certain area.</p> <ol style="list-style-type: none"> 4. If an active nest is found, a minimum 250-foot no-activity buffer will be established around the nest. If a territorial male is found but no nest can be detected, then the approximate centroid of the bird's area of activity will be the point from which the buffer will be applied. The required buffer may be reduced in areas where dense riparian forest occurs between the construction activities and the active nest or where sufficient barriers or topographic relief exists to protect the nest from excessive noise or other disturbance. The biologist will coordinate with the USFWS and CDFW to evaluate exceptions to the minimum no-activity buffer distance on a case-by-case basis. 5. No work will occur within the buffer without verification by a biologist that the nest is inactive and until any fledged young are no longer dependent on adults for food. 6. If a least Bell's vireo and/or its nest is detected during pre-activity surveys, the District will contact the USFWS and CDFG within two working days regarding the presence and location of the bird/nest.
GEN-7	Protection of Burrowing Owls	<ol style="list-style-type: none"> 1. If occupied burrows are identified, a 250 foot radius no work buffer zone will be established around the burrow. The buffer may be modified, with CDFW approval, to take into consideration of paved roads, intervening riparian corridors and levees. 2. No construction work will occur within the 250 foot buffer zone until after the nesting season. 3. After the nesting season work may occur within the 250 foot buffer zone provided: <ol style="list-style-type: none"> a. A qualified biologist monitors the owls for at least 3 days prior to construction to determine baseline foraging behavior (i.e., behavior without construction) b. The same qualified biologist monitors the owls during construction and finds no change in owl foraging behavior in response to construction activities. c. If there is any change in owl foraging behavior as a result of construction activities, these activities will cease within the 250-foot buffer. d. If the owls are gone for at least one week, the project proponent may request approval from the Santa Clara County Habitat Agency that a qualified biologist excavate the usable burrows to prevent owls from re-occupying the site. After the usable burrows are excavated, the buffer zone will be removed and construction may continue. e. Monitoring must continue as described above for the non-breeding season as long as the burrow remains active. 5. Routine use of existing District maintenance roads within the 250 foot buffer will be allowed. However, no construction traffic will be allowed to use the maintenance road during the active nesting period. 6. Exceptions. <ol style="list-style-type: none"> a. Mowing on levees may occur during the nesting season and within 250 feet of active burrows provided the burrows are marked by a qualified biologist. b. No vehicle mounted mowers will be used within 10 ft of occupied burrows. c. A qualified biologist will monitor the mowing within the buffer zone and stop the mowing if burrowing owls are observed on the surface at the nest or another burrow. d. Areas within 10 feet of the burrows may be mowed using hand equipment when no owls are visible on the surface. e. All mowing activities within the buffer zone will be completed within 30 minutes.
GEN-8	Protection of Sensitive	Approved herbicides and adjuvants may be applied in habitat areas for sensitive wildlife species (including

BMP Number	BMP Title	BMP Description
	Fauna Species from Herbicide Use	<p>steelhead, California red-legged frog, California tiger salamander, salt marsh harvest mouse, and Bay checkerspot butterfly); all applications will occur in accordance with federal and state regulations.</p> <p>For sprayable or dust formulations: when the air is calm or moving away from sensitive wildlife habitat, applications will commence on the side nearest the habitat and proceed away from the habitat. When air currents are moving toward habitat, applications will not be made within 200 yards by air or 40 yards by ground upwind from occupied habitat. However, these distances may be modified for the control of invasive species on salmonid streams if the following measures are implemented:</p> <ul style="list-style-type: none"> ▪ A qualified biologist will determine presence/absence of sensitive resources in designated herbicide use areas and develop site-specific control methods (including the use of approved herbicide and surfactants). Proposed herbicide use would be limited to the aquatic formulation of glyphosate (Rodeo or equal). Surfactant use would be limited to non-ionic products, such as Agri-dex, Competitor, or another brand name using the same ingredients. Any modifications to these materials would require review and approval by NMFS and CDFW. ▪ A qualified fisheries biologist will review proposed herbicide application methods and stream reaches. The fisheries biologist would conduct a pre-construction survey (and any other appropriate data research) to determine whether the proposed herbicide application is consistent with SMP approvals concerning biological resources and determine which BMPs would be instituted for work to proceed.
GEN-9	Avoid Impacts to Special-Status Plant Species and Sensitive Natural Vegetation Communities	<p>A qualified botanist will identify special status plant species and sensitive natural vegetation communities and clearly map or delineate them as needed in order to avoid and/or minimize disturbance, using the CDFW protocols and the <i>CNPS Botanical Survey Guidelines</i> to formulate the following protocols:</p> <ol style="list-style-type: none"> 1. A qualified botanist will use the GIS database, CNDDDB, and/or other suitable tools to identify special status plants and sensitive natural vegetation communities located within or near work areas. 2. Surveys of areas identified as sensitive natural communities or suitable habitat for special status plant species will be conducted by a qualified botanist prior to commencement of work. 3. Surveys will be conducted during the appropriate time of the year to adequately identify special-status plants that could occur on the site of proposed maintenance activities. 4. The qualified botanist will ensure avoidance and/or minimize impacts by implementing one or more of the following, as appropriate, per the botanist’s recommendation: <ol style="list-style-type: none"> a) Flag or otherwise delineate in the field the special status plant populations and/or sensitive natural community to be protected; b) Allow adequate buffers around plants or habitat; the location of the buffer zone will be shown on the maintenance design drawings and marked in the field with stakes and/or flagging in such a way that exclusion zones are visible to maintenance personnel without excessive disturbance of the sensitive habitat or population itself (e.g., from installation of fencing). c) Time construction or other activities during dormant and/or non-critical life cycle period; d) Store removed sediment off site; and e) Limit the operation of maintenance equipment to established roads whenever possible. 5. No herbicides, terrestrial or aquatic, will be used in areas identified as potential habitat for special status plants species or containing sensitive natural communities, until a qualified botanist has surveyed the area and determined the locations of special status plant species present. 6. If special status plant species or sensitive communities are present, then a qualified botanist will determine if a given type of vegetation management method is ecologically appropriate for a given area. Alternative

BMP Number	BMP Title	BMP Description
		<p>strategies based on the botanist’s recommendations will be coordinated with appropriate staff.</p> <p>7. All impacts to sensitive natural communities and special status plants identified by the qualified botanist will be avoided and/or minimized</p>
GEN-10	Avoid Impacts to Bay Checkerspot Butterfly and Associated Critical Habitat	<ol style="list-style-type: none"> 1. Areas supporting Bay checkerspot larval host plants will be identified by a qualified botanist and protected from disturbance to the extent feasible, by establishing buffer zones around individual plants or populations. The size of the buffer will be determined by a qualified botanist; the actual distance will depend on the plant species potentially affected and the type of disturbance. No herbicide will be applied to the buffer area, and to the extent feasible, maintenance personnel and equipment will not operate within such areas. 2. Herbicides may be used in serpentine areas that do not contain Bay checkerspot butterfly larval host plants or sensitive plant species and habitat when approved by a qualified botanist and for the following maintenance purposes: <ol style="list-style-type: none"> a) To protect sensitive species and habitat; b) To manage for control of invasive and non-native plants; and/or c) To maintain access to a facility.
GEN-11	Protection of Salt Marsh Harvest Mouse and California Clapper Rail	<ol style="list-style-type: none"> 1. A District qualified biologist will conduct a desk audit to determine whether suitable Salt Marsh Harvest Mouse (SMHM) or California Clapper Rail (CCR) habitat is present in or adjacent to a maintenance activity. 2. Within 7 days prior to work within the range of the Salt Marsh Harvest Mouse (SMHM) or California Clapper Rail (CCR), as depicted on the District’s GIS layers, the proposed project area will be surveyed by a qualified biologist to identify specific habitat areas. Surveyed areas will include work locations and access routes. The range of the salt marsh harvest mouse and California clapper rail is based on the SCVWD’s GIS mapping reflecting occurrence information and potential habitat. If this mapping is revised, it will be provided to the Service for review. 3. To minimize or avoid the loss of individuals, activities within or adjacent to California clapper rail and salt marsh harvest mouse habitat will not occur within two hours before or after extreme high tides (6.5 feet or above) when the marsh plain is inundated, because protective cover for those species is limited and activities could prevent them from reaching available cover. 4. Specific habitat areas are vegetated areas of cordgrass (<i>Spartina</i> spp), marsh gumplant (<i>Grindelia</i> spp.), pickleweed (<i>Sarcocornia pacifica</i>), alkali heath, (<i>Frankenia</i> sp.), and other high marsh vegetation, brackish marsh reaches of creek with heavy accumulations of bulrush thatch (old stands), and high water refugia habitat that may include annual grasses, and shrubs immediately adjacent to channels. 5. Within the identified specific habitat areas, vegetation will be removed by hand from areas to be directly impacted by the work activities if possible (hand removal of vegetation in some channels may not be possible). If within the mapped range of the mouse but outside of areas identified as specific habitat areas, then other methods may be possible. 6. Prior to the initiation of work each day for all vegetation management work, ground or vegetation disturbance, operation of large equipment, grading, sediment removal, and bank stabilization work and prior to expanding the work area, if suitable habitat occurs within the immediate work area, a qualified biologist will conduct a pre-construction survey of all suitable habitat that may be directly or indirectly impacted by the day’s activities (work area, access routes, staging areas). <ol style="list-style-type: none"> a. If during the initial daily survey or during work activities a CCR is observed within or immediately

BMP Number	BMP Title	BMP Description
		<p>adjacent to the work area (50 feet), initiation of work will be delayed until the CCR leaves the work area.</p> <p>b. If during the initial daily survey or during work activities a SMHM or similar rodent is observed within or immediately adjacent to the work area (50 feet), initiation of work will be delayed until a <i>Site Specific Species Protection Form</i> can be developed and implemented by a qualified biologist to protect the SMHM or similar rodent is developed and implemented by the qualified biologist. Acceptable plan activities may include one or more of the following activities: 1) establishment of a buffer zone at least 50 feet in radius from the rodent; 2) ongoing active monitoring, 3) construction of silt fence barrier between maintenance work and location of the rodent, 4) delay of work activity until the qualified biologist can provide CDFW and the Service a suggested course of action and seek concurrence.</p> <p>7. Mowing using heavy equipment (tractors, boom mowers, rider mowers) will not be conducted in habitat areas or within 50 feet of habitat areas. If mowing with hand equipment is necessary within 50 feet of habitat areas, an on-site monitor will observe the area in front of the mower from a safe vantage point while it is in operation. If SMHM are detected within the area to be mown, no mowing will occur in that area. If CCR are detected within the area to be mown, the mowing will stop until the individual(s) have left the work area.</p> <p>8. See ANI-2 for additional restrictions.</p> <p>9. If visual observation cannot confirm California clapper rail left the work area then it is assumed that the individual(s) remains in the work area and the work will not resume until the area has been thoroughly surveyed (and absence confirmed) or the Service has been contacted for guidance.</p>
GEN-12	Protection of Special-Status Amphibian and Reptile Species	<p>1. A District qualified biologist will conduct a desk audit to determine whether suitable special-status amphibian or reptile habitat is present in or adjacent to a maintenance activity based on all available information including the habitats modeled in the Valley Habitat Plan.</p> <p>2. If the District Wildlife or Fisheries Biologist determines that a special-status amphibian or reptile could occur in the activity area, a qualified biologist will conduct one daytime and one nighttime survey within a 7 day period preceding the onset of maintenance activities.</p> <p>a. If a special-status amphibian or reptile, or the eggs or larvae of a special status amphibian or reptile, are found within the activity area during a pre-activity survey or during project activities, the qualified biologist shall notify the project proponent about the special-status species and conduct the following work specific activities:</p> <p>i. For minor maintenance activities and for vegetation removal activities that will take less than 1 day, a qualified biologist shall conduct a special status species survey on the morning of and prior to the scheduled work.</p> <p>A. If no special status species is found, the work may proceed.</p> <p>B. If eggs or larvae of a special status species are found, a buffer will be established around the location of the eggs/larvae and work may proceed outside of the buffer zone. No work will occur within the buffer zone. Work within the buffer zone will be rescheduled until the time that eggs have hatched and/or larvae have metamorphosed.</p> <p>C. If an active western pond turtle nest is detected within the activity area, a 50-foot buffer zone around the nest will be established and maintained during the breeding and nesting season (April 1 – August 31). The buffer zone will remain in place until the young have left the nest, as determined by a qualified biologist.</p> <p>D. If adults or non-larval juveniles of a special status species are found, one of the following two</p>

BMP Number	BMP Title	BMP Description
		<p>procedures will be implemented:</p> <ul style="list-style-type: none"> i. If, in the opinion of the qualified biologist, capture and removal of the individual to a safe place outside of the work area is less likely to result in adverse effects than leaving the individual in place and rescheduling the work (e.g., if the species could potentially hide and be missed during a follow-up survey), the individual will be captured and relocated by a qualified biologist (with USFWS and/or CDFW approval, depending on the listing status of the species in question), and work may proceed. ii. If, in the opinion of the qualified biologist, the individual is likely to leave the work area on its own, and work can be feasibly rescheduled, a buffer will be established around the location of the individual(s) and work may proceed outside of the buffer zone. No work will occur within the buffer zone. Work within the buffer zone will be rescheduled. <p>ii. For minor maintenance and vegetation removal activities that will take more than 1 day, the qualified biologist shall conduct a special-status species survey on each morning of and prior to the scheduled work commencing.</p> <ul style="list-style-type: none"> E. If eggs or larvae of a special status species are found, a buffer will be established around the location of the eggs/larvae and work may proceed outside of the buffer zone. No work will occur within the buffer zone. Work within the buffer zone will be rescheduled until the time that eggs have hatched and/or larvae have metamorphosed. F. If an active western pond turtle nest is detected within the activity area, a 50 ft-buffer zone around the nest will be established and maintained during the breeding and nesting season (April 1 – August 31). The buffer zone will remain in place until the young have left the nest, as determined by a qualified biologist. G. If adults or non-larval juveniles of a special status species are found, the individual will be captured and relocated by a qualified biologist (with USFWS and/or CDFW approval, depending on the listing status of the species in question), and work may proceed. <p>iii. For Sediment Removal and Bank Stabilization Projects the wildlife or fisheries biologist in cooperation with the project proponent shall complete a <i>Site Specific Species Protection Form for the project</i>. Elements of the form include: work rescheduling, training work crews, daily surveys, establishment of buffers and buffer fencing, on-site monitoring, habitat modification in advance of work activities, capture and relocation of individual special-status species, methods of documentation, and reporting of results.</p> <ul style="list-style-type: none"> b. If no special status amphibian or reptile is found within the activity area during a pre-activity survey, the work may proceed. c. During animal conflict management activities, if special status species are found within a burrow proposed for destruction, a qualified biologist will determine an appropriate buffer distance around that burrow to ensure adequate protection of the habitat. The buffer area may include not destroying adjacent burrows as that may damage subterranean networks of the occupied burrow or produce substrate vibrations which could interfere with prey detection mechanisms. If two consecutive follow up surveys are conducted (spaced 30 days apart) in which the burrow is found to be unoccupied, work can proceed as planned. A naturally found back filled burrow known to have been inhabited by a special-status species will be presumed to still be occupied by that species and a clearly delineated buffer demarcation of the burrow area will be in place for the duration of nearby work activities. In rare instances in which destruction of the burrow is not avoidable during animal conflict management, the animal will be relocated to a safe burrow outside the

BMP Number	BMP Title	BMP Description
		<p>impact area, with USFWS and/or CDFW approval, depending on the listing status of the species in question. A biologist will observe the relocated animal until it is certain that the animal is not in immediate danger of desiccation or predation.</p>
GEN-13	Protection of Bat Colonies	<ol style="list-style-type: none"> 1. A District Wildlife Biologist will conduct a desk audit to determine whether suitable habitat (appropriate roost trees or anthropogenic structures) is present for bat colonies within 100 feet of the work site, staging areas, or access routes. 2. If potential bat colony habitat is determined to be present, within two weeks prior to the onset of work activities a qualified biologist will conduct a survey to look for evidence of a bat use. If evidence is observed, or if potential roost sites are present in areas where evidence of bat use might not be detectable (such as a tree cavity), an evening survey and/or nocturnal acoustic survey may be necessary to determine if the bat colony is active and to identify the specific location of the bat colony. 3. If an active bat colony is present then the qualified biologist will make the following determinations: <ol style="list-style-type: none"> a. The work can proceed without unduly disturbing the bat colony b. There is a need for a buffer zone to prevent disturbance to the bat colony, and implementation of the buffer zone (determined on a case-by-case basis by a qualified biologist) will reduce or eliminate the disturbance to an acceptable level. 4. If a bat colony is found in a tree or structure that must be removed or physically disturbed the qualified biologist will consult with DFW prior to initiating any removal or exclusion activities.
GEN-14	Protection of San Francisco Dusky-footed Woodrat	<ol style="list-style-type: none"> 1. Prior to work within riparian, oak woodland, or coyote brush scrub habitat, or the removal of any oak trees outside these habitats, a District Wildlife Biologist will conduct a desk audit to determine whether woodrats could be present within suitable habitat for San Francisco dusky-footed woodrat or is known to be present in or adjacent to a maintenance activity site. 2. If the District Wildlife Biologist determines that no San Francisco dusky-footed woodrat habitat is present, or there is habitat present but it will not be affected by the maintenance activity, then no further action is required. 3. If the District Wildlife Biologist determines that suitable San Francisco dusky-footed woodrat habitat is present and may be affected by the maintenance activity, a qualified biologist shall conduct a pre-activity survey within 2 weeks prior to the start of work to determine if woodrat nests are present, or within 5 feet of, the immediate activity area. If woodrat nests are determined to be present, the following measures shall be implemented: <ol style="list-style-type: none"> a. To the extent feasible, impacts to woodrat nests will be avoided by maintaining a minimum 5-ft buffer between maintenance activities and nests. Even if a 5-ft buffer cannot be maintained, the District will minimize impacts to nests by avoiding the direct destruction or modification of the nests to the extent feasible. b. If one or more woodrat nests are determined to be present and physical disturbance or destruction of the nests cannot be avoided, then the woodrats shall be evicted from their nests and the nest material relocated outside of the disturbance area, prior to onset of activities that would disturb the nest, to avoid injury or mortality of the woodrats. First, an alternate location for the nest material shall be chosen by a qualified biologist based on the following criteria: 1) proximity to current nest location; 2) safe buffer distance from planned work; 3) availability of food resources; and 4) availability of cover. An alternate nest structure will then be built at the chosen location. The structure will be made up of small logs (e.g., available materials 2 inches in diameter or greater) stacked to provide a foundation

BMP Number	BMP Title	BMP Description
		<p>on which the woodrats can add nest material. Subsequently, during the evening hours (i.e., within 2 hours prior to sunset), a qualified biologist will slowly dismantle the existing woodrat nest to allow any woodrats to flee and seek cover. All sticks from the nest will be collected and spread over the alternate structure. If young woodrats that are still dependent on their mother are discovered, relocation efforts will cease for the evening and the California Department of Fish and Wildlife will be contacted for guidance on how to proceed.</p>
GEN-15	Salvage Native Aquatic Vertebrates from Dewatered Channels	<p>If fisheries or native aquatic vertebrates are present when cofferdams, water bypass structures, and silt barriers are to be installed, a fish and native aquatic vertebrate relocation plan shall be implemented to ensure that fish and native aquatic vertebrates are not stranded. Relocation efforts will be based on the District's Fish Relocation Guidelines (Attachment B). Streams that support a sensitive species (i.e. steelhead) will require a relocation effort and/ or initial onsite monitoring by a qualified biologist depending on seasonal conditions:</p> <ol style="list-style-type: none"> 1. In non-tidal channels, where water is to be diverted, prior to the start of work or during the installation of water diversion structures, native aquatic vertebrates shall be captured in the work area and transferred to another reach as determined by a qualified biologist. Timing of work in streams that supports a significant number of amphibians will be delayed until metamorphosis occurs to minimize impacts to the resource. Capture and relocation of aquatic native vertebrates is not required at individual work sites when site conditions preclude reasonably effective operation of capture gear and equipment. 2. Aquatic invertebrates will not be transferred (other than incidental catches) because of their anticipated abundance and colonization after completion of the repair work.
GEN-15.5	Avoidance of Impacts on the San Joaquin Kit Fox	<ol style="list-style-type: none"> 1. A qualified District biologist will conduct a desk audit to determine whether an SMP activity will occur in an area where the San Joaquin kit fox could potentially occur (i.e., roughly east of Frazier Lake Road and south of Bloomfield Avenue), and in potential habitat for the species. 2. If the District biologist determines that an SMP activity could occur in an area that could potentially support a kit fox, the SCVWD will implement applicable pre-activity surveys and other measures in accordance with the USFWS's <i>San Joaquin Kit Fox Survey Protocol for the Northern Range</i>, as follows: <ol style="list-style-type: none"> a) Conduct a preconstruction/pre-activity survey no less than 14 days and no more than 30 days prior to the beginning of project implementation. Surveys shall identify kit fox habitat features on the project site and evaluate use by kit fox and, if possible, and assess the potential impacts to the kit fox by the proposed activity. The status of all dens shall be determined and mapped in accordance with the survey protocol. b) If a natal/pupping den is discovered within the project area or within 200 feet of the project boundary, the USFWS shall be immediately notified. Disturbance to all San Joaquin kit fox dens should be avoided to the maximum extent possible. Destruction of any known or natal/pupping kit fox den would require take authorization from the USFWS. c) The project proponent will establish exclusion zones around the kit fox dens, if determined to be present. The configuration of the exclusion should have a radius measured outward from the entrance or cluster of entrances. The following radii are minima to be applied: <ul style="list-style-type: none"> ▪ Potential den: 50 feet ▪ Known den: 100 feet ▪ Natal/pupping den: Service must be contacted (occupied and unoccupied) ▪ Atypical den: 50 feet.

BMP Number	BMP Title	BMP Description
		3. If take of the San Joaquin kit fox will occur, take authorization from the USFWS and CDFW will be necessary.

General Maintenance Practices

GEN-16	In-Channel Minor Activities	For in-channel minor work activities, work will be conducted from the top of the bank if access is available and there are flows in the channel.
GEN-17	Employee/Contractor Training	All appropriate District staff and contractors will receive annual training on Stream Maintenance Program BMPs. The training will also include an overview of special-status species identification and habitat requirements. District staff and contractors will receive fact sheets to assist with in-the-field identification of special-status species and their habitats.
GEN-18	Paperwork Required On-site	<ol style="list-style-type: none"> Copies of regulatory permits related to the Stream Maintenance Program will be kept on-site and available for review, if requested by regulatory personnel. Copies of the Stream Maintenance Program Manual and this BMP Manual will be kept on-site.
GEN-19	Work Site Housekeeping	<ol style="list-style-type: none"> District employees and contractors will maintain the work site in neat and orderly conditions on a daily basis, and will leave the site in a neat, clean, and orderly condition when work is complete. Slash, sawdust, cuttings, etc. will be removed to clear the site of vegetation debris. As needed, paved access roads and trails will be swept and cleared of any residual vegetation or dirt resulting from the maintenance activity. For activities that last more than one day, materials or equipment left on the site overnight will be stored as inconspicuously as possible, and will be neatly arranged. Any materials and equipment left on the site overnight will be stored to avoid erosion, leaks, or other potential impacts to water quality (see BMPs GEN-24). The District's maintenance crews are responsible for properly removing and disposing of all debris incurred as a result of construction within 72 hours of project completion. All trash that is brought to a project site during maintenance activities (e.g., plastic water bottles, plastic lunch bags, cigarettes) will be collected at the site daily.
GEN-20	Erosion and Sediment Control Measures	<ol style="list-style-type: none"> Soils exposed due to maintenance activities will be seeded and stabilized using hydroseeding, straw placement, mulching, and/or erosion control fabric. These measures will be implemented such that the site is stabilized and water quality protected prior to significant rainfall. The channel bed and areas below the Ordinary High Water Mark (OHWM) are exempt from this BMP. The preference for erosion control fabrics will be to consist of natural fibers; however, steeper slopes and areas that are highly erodible may require more structured erosion control methods. No non-porous fabric will be used as part of a permanent erosion control approach. Plastic sheeting may be used to temporarily protect a slope from runoff, but only if there are no indications that special-status species would be impacted by the application. Erosion control measures will be installed according to manufacturer's specifications. Appropriate measures include, but are not limited to, the following: <ul style="list-style-type: none"> Silt Fences Straw Bale Barriers Brush or Rock Filters Storm Drain Inlet Protection Sediment Traps

BMP Number	BMP Title	BMP Description
		<ul style="list-style-type: none"> ○ Sediment Basins ○ Erosion Control Blankets and Mats ○ Soil Stabilization (i.e. tackified straw with seed, jute or geotextile blankets, etc.) ○ Wood chips ○ Straw mulch <p>5. All temporary construction-related erosion control methods shall be removed at the completion of the project (e.g. silt fences).</p> <p>6. Surface barrier applications installed as a method of animal conflict management, such as chain link fencing, woven geotextiles, and other similar materials, will be installed no longer than 300 feet, with at least an equal amount of open area prior to another linear installation; and only on one side of levee slopes. Inboard and outboard areas will only have installations set in an alternating pattern, such that no inboard and outboard levee faces would have erosion control blankets along the same levee stationing.</p> <p>7. Each maintenance site will be visually inspected at least once daily during extended storm events to confirm that BMPs are effective and maintained as necessary.</p> <p>8. Each maintenance site will be visually inspected within two business days (48 hours) after each significant rain event to determine whether BMPs were effective and identify the need to modify or maintain existing BMPs or include additional BMPs to be protective.</p>
GEN-21	Staging and Stockpiling of Materials	<p>1. To protect on-site vegetation and water quality, staging areas should occur on access roads, surface streets, or other disturbed areas that are already compacted and only support ruderal vegetation. Similarly, all maintenance equipment and materials (e.g., road rock and project spoil) will be contained within the existing service roads, paved roads, or other pre-determined staging areas.</p> <p>2. Building materials and other maintenance-related materials, including chemicals and sediment, will not be stockpiled or stored where they could spill into water bodies or storm drains. Materials will not be stockpiled longer than seven (7) calendar days.</p> <p>3. No runoff from the staging areas may be allowed to enter water ways, including the creek channel or storm drains, without being subjected to adequate filtration (e.g., vegetated buffer, swale, hay wattles or bales, silt screens).</p> <p>4. The discharge of decant water to water ways from any on-site temporary sediment stockpile or storage areas is prohibited.</p> <p>5. Wet material removed from an isolated creek reach may be pulled to the side of the channel (within the channel and below top of bank) and allowed to naturally drain prior to removal from the channel. Pulled material will be removed from the channel prior to deactivation of the site or forecast of rain.</p> <p>6. During the wet season, no stockpiled soils will remain exposed, unless surrounded by properly installed and maintained (i.e., per manufacturer specifications) silt fencing or other means of erosion control. During the dry season; exposed, dry stockpiles will be watered, enclosed, covered, or sprayed with non-toxic soil stabilizers (GEN-24).</p> <p>7. All pipes, culverts, or similar structures stored at a site within sensitive species areas, for one or more overnight periods shall be securely capped prior to storage or inspected before the pipe is subsequently moved. If any potential special-status species are observed within a pipe, a District biologist shall be consulted on what steps should be taken to protect the species. If a District biologist is on-site, they may remove the special status species from the pipes and relocate to the nearest appropriate and unaffected habitat.</p>

BMP Number	BMP Title	BMP Description
GEN-22	Sediment Transport	To prevent sediment-laden water from being released back into waterways during transport of spoils to disposal locations, truck beds will be lined with an impervious material (e.g., plastic), or the tailgate blocked with wattles, hay bales, or other appropriate filtration material. Trucks may then drain excess water by slightly tilting the loads and allowing the water to drain out through the applied filter, but only within the active project area of the creek where the sediment is being loaded into the trucks or within an identified vegetated area (swale) that is separated from the creek.
GEN-23	Stream Access	<p>District personnel will use existing access ramps and roads to the extent feasible. If necessary to avoid large mature trees, native vegetation, or other significant habitat features, temporary access points will be constructed in a manner that minimizes impacts according to the following guidelines:</p> <ol style="list-style-type: none"> 1. Temporary access points will be constructed as close to the work area as possible to minimize equipment transport 2. In considering channel access routes, slopes of greater than 20 percent will be avoided, if possible. 3. Any temporary fill used for access will be removed upon completion of the project and pre-project topography will be restored to the extent possible. 4. When temporary access is removed, disturbed areas will be revegetated or filled with compacted soil, seeded, and/or stabilized with erosion control fabric immediately after construction to prevent future erosion. 5. Personnel will use the appropriate equipment for the job that minimizes impacts and disturbance to the stream bottom. Appropriately-tired vehicles, either tracked or wheeled, will be used depending on the site and maintenance activity.
GEN-24	On-Site Hazardous Materials Management	<ol style="list-style-type: none"> 1. An inventory of all hazardous materials used (and/or expected to be used) at the worksite and the end products that are produced (and/or expected to be produced) after their use will be maintained by the worksite manager. 2. As appropriate, containers will be properly labeled with a “Hazardous Waste” label and hazardous waste will be properly recycled or disposed of off-site. 3. Contact of chemicals with precipitation will be minimized by storing chemicals in watertight containers with appropriate secondary containment to prevent any spillage or leakage. 4. Quantities of toxic materials, such as equipment fuels and lubricants, will be stored with secondary containment that is capable of containing 110% of the primary container(s). 5. Petroleum products, chemicals, cement, fuels, lubricants, and non-storm drainage water or water contaminated with the aforementioned materials will not contact soil and not be allowed to enter surface waters or the storm drainage system. 6. All toxic materials, including waste disposal containers, will be covered when they are not in use, and located as far away as possible from a direct connection to the storm drainage system or surface water. 7. Sanitation facilities (e.g., portable toilets) will be placed outside of the creek channel and floodplain. Direct connections with soil, the storm drainage system, and surface waters will be avoided. 8. Sanitation facilities will be regularly cleaned and/or replaced, and inspected daily for leaks and spills.-
GEN-25	Existing Hazardous Materials	If hazardous materials, such as oil, batteries or paint cans, are encountered at the maintenance sites, the District will carefully remove and dispose of them according to applicable regulatory requirements. District staff will wear proper protective gear and store the waste in appropriate hazardous waste containers until it can be disposed at a hazardous waste facility.
GEN-26	Spill Prevention and Response	The District will prevent the accidental release of chemicals, fuels, lubricants, and non-storm drainage water into channels following these measures:

BMP Number	BMP Title	BMP Description
		<ol style="list-style-type: none"> 1. District field personnel will be appropriately trained in spill prevention, hazardous material control, and clean up of accidental spills. 2. Equipment and materials for cleanup of spills will be available on site and spills and leaks will be cleaned up immediately and disposed of according to applicable regulatory requirements. 3. Field personnel will ensure that hazardous materials are properly handled and natural resources are protected by all reasonable means. 4. Spill prevention kits will always be in close proximity when using hazardous materials (e.g., at crew trucks and other logical locations). All field personnel will be advised of these locations. 5. District staff will routinely inspect the work site to verify that spill prevention and response measures are properly implemented and maintained. <p><i>Spill Response Measures:</i></p> <p>For small spills on impervious surfaces, absorbent materials will be used to remove the spill, rather than hosing it down with water. For small spills on pervious surfaces such as soil, the spill will be excavated and properly disposed rather than burying it. Absorbent materials will be collected and disposed of properly and promptly.</p> <p>If a hazardous materials spill occurs that cannot be contained or cleaned up with the onsite materials, the onsite District field personnel will be responsible for immediately initiating an emergency response sequence by notifying the proper authorities (i.e., District Emergency Response (ER) Team and public fire and hazmat agencies) of the release; taking appropriate defensive steps from a safe distance to secure the site to minimize damage to people, environment, and property (PEP); and deferring all other response activities to public emergency response agencies and/or the District Emergency Response (ER) Team or District ER Contractor. Depending on the nature of the release, the District ER Team’s actions will include: urgent (responding within 2 hours of notification) field response site reconnaissance, emergency sequence initiation, defensive containment, release control, incident command; or priority (non 2-hour) field response site reconnaissance and clean-up operations.</p> <p>If a “reportable” spill of petroleum products occurs, the District’s Stream Maintenance Implementation Program Manager will be notified and action taken to contact the appropriate safety and cleanup crews. A reportable spill is defined as when:</p> <ul style="list-style-type: none"> ▪ a film or sheen on, or discoloration of, the water surface or adjoining bank/shoreline is observed; or ▪ a sludge or emulsion is deposited beneath the surface of the water or adjoining banks/shorelines (40 Code of Federal Regulations 110); or when ▪ another violation of water quality standards is observed. <p>A written description of the reportable release must be submitted to the appropriate Regional Water Quality Control Board and the California Department of Toxic Substances Control (DTSC). This submittal must contain a description of the release, including the type of material and an estimate of the amount spilled, the date of the release, an explanation of why the spill occurred, and a description of the steps taken to prevent and control future releases.</p> <p>If an appreciable spill has occurred, and results determine that project activities have adversely affected surface water or groundwater quality, a detailed analysis will be performed to the specifications of DTSC to identify the likely cause of contamination. This analysis will include recommendations for reducing or eliminating the source or mechanisms of contamination. Based on this analysis, the District or contractors will select and implement</p>

BMP Number	BMP Title	BMP Description
		measures to control contamination, with a performance standard that surface and groundwater quality will be returned to baseline conditions. These measures will be subject to approval by the District, DTSC, and the Regional Water Quality Control Board.
GEN-27	Existing Hazardous Sites	Upon selection of maintenance project locations, the District will conduct a search for existing known contaminated sites, as part of its annual preparation of the Notice of Proposed Work (NPW), on the State Water Resource Control Board's GeoTracker Web site (http://www.geotracker.waterboards.ca.gov). The Geotracker search will only be performed for the District's ground disturbing activities. For any proposed ground disturbing maintenance sites located within 1,500 feet of any "open" sites where contamination has not been remediated, the District will contact the RWQCB case manager listed in the database. The District will work with the case manager to ensure maintenance activities would not affect cleanup or monitoring activities or threaten the public or environment.
GEN-28	Fire Prevention	<ol style="list-style-type: none"> 1. All earthmoving and portable equipment with internal combustion engines will be equipped with spark arrestors. 2. During the high fire danger period (April 1–December 1), work crews will :-a)- have appropriate fire suppression equipment available at the work site.
GEN-29	Dust Management	<p>The District will implement the Bay Area Air Quality Management District's (BAAQMD) required Dust Control Measures (http://www.baaqmd.gov/~media/Files/Planning%20and%20Research/CEQA/BAAQMD%20CEQA%20Guidelines%20May%202011.ashx?la=en). Current measures stipulated by the BAAQMD Guidelines include the following:</p> <ol style="list-style-type: none"> 1. All exposed surfaces (e.g., parking areas, staging areas, soil piles, graded areas, and unpaved access roads) shall be watered two times per day. 2. All haul trucks transporting soil, sand, or other loose material off-site shall be covered. 3. All visible mud or dirt track-out onto adjacent public roads shall be removed using wet power vacuum street sweepers at least once per day. The use of dry power sweeping is prohibited. 4. Water used to wash the various exposed surfaces (i.e., parking areas, staging areas, soil piles, graded areas, etc.) will not be allowed to enter the water way. 5. All vehicle speeds on unpaved roads shall be limited to 15 mph. 6. All roadways, driveways, and sidewalks to be paved shall be completed as soon as possible. Building pads shall be laid as soon as possible after grading unless seeding or soil binders are used. 7. Idling times shall be minimized either by shutting equipment off when not in use or reducing the maximum idling time to 5 minutes (as required by the California airborne toxics control measure Title 13, Section 2485 of California Code of Regulations [CCR]). Clear signage shall be provided for construction workers at all access points. 8. All construction equipment shall be maintained and properly tuned in accordance with manufacturer's specifications. All equipment shall be checked by a certified visible emissions evaluator. 9. Post a publicly visible sign with the telephone number and person to contact at the lead agency regarding dust complaints. This person shall respond and take corrective action within 48 hours. The Air District's phone number shall also be visible to ensure compliance with applicable regulations.

BMP Number	BMP Title	BMP Description
GEN-30	Vehicle and Equipment Maintenance	<ol style="list-style-type: none"> 1. All vehicles and equipment will be kept clean. Excessive build-up of oil and grease will be prevented. 2. All equipment used in the creek channel will be inspected for leaks each day prior to initiation of work. Maintenance, repairs, or other necessary actions will be taken to prevent or repair leaks, prior to use. 3. Incoming vehicles and equipment (including delivery trucks, and employee and subcontractor vehicles) will be checked for leaking oil and fluids. Vehicles or equipment visibly leaking operational fluids will not be allowed on-site. 4. No heavy equipment will operate in a live stream. This will not apply to activities for which no other option exists, such as sediment removal which cannot be conducted from top of bank, etc. In these cases, dewatering will be conducted as necessary, following the protocols in BMPs GEN-33 or GEN-34. 5. No equipment servicing will be done in the creek channel or immediate floodplain, unless equipment stationed in these locations cannot be readily relocated (i.e., pumps and generators). 6. If emergency repairs are required in the field, only those repairs necessary to move equipment to a more secure location, and that can be performed without releasing any material into the floodway or water, will be conducted in the channel or floodplain. 7. If necessary, all servicing of equipment done at the job site will be conducted in a designated, protected area to reduce threats to water quality from vehicle fluid spills. Designated areas will not directly connect to the ground, surface water, or the storm drain system. The service area will be clearly designated with berms, sandbags, or other barriers. Secondary containment, such as a drain pan, to catch spills or leaks will be used when removing or changing fluids. Fluids will be stored in appropriate containers with covers, and properly recycled or disposed of offsite.
GEN-31	Vehicle Cleaning	<ol style="list-style-type: none"> 1. Equipment will be cleaned of any visible sediment or vegetation clumps before transferring and using in a different watershed to avoid spreading pathogens or exotic/invasive species. 2. Vehicle and equipment washing can occur on-site only as needed to prevent the spread of sediment, pathogens or exotic/invasive species. No runoff from vehicle or equipment washing is allowed to enter water bodies, including creek channels and storm drains, without being subjected to adequate filtration (e.g., vegetated buffers, straw wattles or bales, fiber rolls, and silt screens). The discharge of decant water from any on-site wash area to water bodies or to areas outside of the active project site is prohibited. Additional vehicle/equipment washing will occur at the approved wash area in the District's corporation yard.
GEN-32	Vehicle and Equipment Fueling	<ol style="list-style-type: none"> 1. No fueling will be done in the channel (top-of-bank to top-of-bank) or immediate floodplain unless equipment stationed in these locations cannot be readily relocated (e.g., pumps and generators). 2. All off-site fueling sites (i.e., on access roads above the top-of-bank) will be equipped with secondary containment and avoid a direct connection to soil, surface water, or the storm drainage system. 3. For stationary equipment that must be fueled on-site, secondary containment, such as a drain pan or drop cloth, will be used to prevent accidental spills of fuels from reaching the soil, surface water, or the storm drain system.

BMP Number	BMP Title	BMP Description
Dewatering		
GEN-33	Dewatering for Non-Tidal Sites	<p>When sediment removal and bank stabilization work area includes a flowing stream, the entire streamflow will be diverted around the work area by construction of a temporary dam and/or bypass. Where appropriate, stream flow diversions will occur via gravity driven systems.</p> <p><i>A. Planning to avoid and minimize impacts to water quality and aquatic wildlife:</i></p> <ol style="list-style-type: none"> 1. For construction and monitoring of a stream flow bypass, the <i>Sediment Removal and Bank Stabilization Projects</i> checklist will be completed. 2. Recommendations by a qualified Fisheries Biologist to protect native fisheries and aquatic vertebrates will be incorporated into the bypass design. The recommendations may include but are not limited to: <ol style="list-style-type: none"> i. Screening the stream flow diversion source or pump to prevent entrainment of native fish or amphibian species. The screening dimensions will be appropriate to the species present. ii. Relocation of native aquatic vertebrates. This will include the methods to be used to capture and hold and move the aquatic vertebrates and a description of where the aquatic vertebrates will be relocated. 3. Depending on the channel configurations, sediment removal activities may occur where the flows are not bypassed around the work site as long as a berm is left between the work area and stream flows to minimize water quality impacts during excavation activities. The berm between the work and the live channel will be wide enough to prevent introduction of turbid water from the cell into the live channel. <p><i>B. Construction:</i></p> <ol style="list-style-type: none"> 1. The construction of facilities will be based on the water bypass plan. 2. Cofferdams will be installed both upstream and downstream of the work area to minimize impacts or the distance necessary to accomplish effective passive systems. 3. In streams where water may enter the construction site from downstream (reverse flow) additional coffer dams (downstream) may be necessary. When multiple coffer dams are constructed, the upstream dam will be constructed first. 4. Instream cofferdams will only be built from materials such as sandbags, earth fill, clean gravel, or rubber bladders which will cause little or no siltation or turbidity. 5. Plastic sheeting will be placed over k-rails, timbers, and earth fill to minimize water seepage into and out of the maintenance areas. The plastic sheets will be firmly anchored, using sandbags, to the streambed to minimize water seepage. 6. When pumping is necessary to dewater a work site, a temporary siltation basin and/or use of silt bags may be required to prevent sediment from re-entering the wetted channel. Pump intakes will be screened to prevent harm to aquatic wildlife. 7. If necessary to prevent erosion an energy dissipater will be constructed at the discharge point. 8. Timing of flow diversions will be coordinated with the completion of the dam structure to facilitate not drying up the downstream creek area and to minimize dry back conditions. <p><i>C. Implementation:</i></p> <ol style="list-style-type: none"> 1. Water flows downstream of the project site will be maintained to prevent stranding aquatic vertebrates.

BMP Number	BMP Title	BMP Description
		<ol style="list-style-type: none"> 2. Water diverted around work sites and water detained by coffer dams will be protected from maintenance activity-related pollutants, such as soils, equipment lubricants or fuels. 3. The <i>Fish Relocation Guidelines</i> (Attachment B) will be implemented to ensure that fish and other aquatic vertebrates are not stranded during construction and implementation of channel dewatering. <ol style="list-style-type: none"> a) Native aquatic vertebrates shall be captured in the work area and transferred to another reach as determined by a qualified biologist. Timing of work in streams that supports a significant number of amphibians will be delayed until metamorphosis occurs to minimize impacts to the resource. Capture and relocation of aquatic native vertebrates is not required at individual work sites when site conditions preclude reasonably effective operation of capture gear and equipment. b) Aquatic invertebrates will not be transferred (other than incidental catches) because of their anticipated abundance and colonization after completion of the repair work. 4. Filtration devices (silt bags attached to the end of discharge hoses and pipes to remove sediment from discharged water) or settling basins will be provided as necessary at discharge sites to ensure that the turbidity of discharged water is not visibly more turbid than the water in the channel upstream of the maintenance site. If increases in turbidity are observed, additional measures will be implemented such as a larger settling basin or additional filtration. If increases in turbidity persist, the District’s Stream Maintenance Program Implementation Project Manager will be alerted since turbidity measurements may be required. 5. Water remaining in the work area will be removed by evaporation, seepage, or pumping. When pumping is required to dewater a site, the decanted water will be discharged with water bypassed around the site or in a separate erosion control – energy dissipation area/vegetated swale. The turbidity of discharged water will not be visibly more turbid than the receiving water. <p><i>Deconstruction:</i></p> <ol style="list-style-type: none"> 1. When maintenance is completed, the flow diversion structure will be removed as soon as possible. Impounded water will be released at a reduced velocity to minimize erosion, turbidity, or harm to downstream habitat. 2. Removal will normally proceed from downstream in an upstream direction. 3. When diversion structures are removed, the ponded water will be directed back into the low-flow channel in a phased manner to minimize erosion and downstream water quality impacts. Normal flows will be restored. 4. The area disturbed by flow bypass mechanisms will be restored to the pre-project condition at the completion of the project (to the extent practical). This may include, but is not limited to, recontouring the area and planting of riparian vegetation.

BMP Number	BMP Title	BMP Description
GEN-34	Dewatering in Tidal Work Areas	<p>For tidal areas, a downstream cofferdam will be constructed to prevent the work area from being inundated by tidal flows.</p> <ol style="list-style-type: none"> 1. Installation of cofferdams and fish exclusion measures will be installed at low tide when the channel and project site are at their driest. 2. It is preferable to not use any bypass pipes when work is being conducted on one side of the channel, if isolated by the cofferdam, and flows can continue on the other side of the creek channel without entering the project area. 3. If downstream flows cannot be diverted around the project site, the creek waters will be transmitted around the site through cofferdam bypass pipes. Waters discharged through tidal cofferdam bypass pipes will not exceed 50 NTUs over the background levels of the tidal waters into which they are discharged. 4. Cofferdams in tidal areas may be made from earthen or gravel material. If earth is used, the downstream and upstream faces will be covered by a protected covering (e.g., plastic or fabric) if needed to minimize erosion. A protected covering or sheeting will be placed on the water side of an earthen coffer dam to protect water quality. 5. When maintenance is completed, the cofferdams and bypass pipes will be removed as soon as possible but no more than 72 hours after work is completed. Flows will be restored at a reduced velocity to minimize erosion, turbidity, or harm to downstream habitat.
GEN-35	Pump/Generator Operations and Maintenance	<p>When needed to assist in channel dewatering, pumps and generators will be maintained and operated in a manner that minimizes impacts to water quality and aquatic species.</p> <ol style="list-style-type: none"> 1. Pumps and generators will be maintained according to manufacturers' specifications to regulate flows to prevent dryback or washout conditions. 2. Pumps will be operated and monitored to prevent low water conditions, which could pump muddy bottom water, or high water conditions, which creates ponding. 3. All pump intakes will be screened. Pumps in steelhead creeks will be screened according to NMFS criteria (http://www.swr.noaa.gov/sr/fishscrn.pdf) to prevent entrainment of steelhead.
Public Safety		
GEN-36	Public Outreach	<p>The public will be informed of stream maintenance work prior to the start of work as part of the preparation of the NPW for all projects in the NPW:</p> <ol style="list-style-type: none"> 1. Each spring, a newspaper notice will be published with information on the NPW work sites, approximate work dates, and contact information. 2. Neighborhood Work Notices will be distributed as part of the NPW preparation prior to the start of work. 3. Local governments (cities and County) will be notified of scheduled maintenance work. The NPW will be submitted to the public works departments, local fire districts, and the District's Flood Protection and Watershed Advisory Committees. 4. The District will post specific information on individual maintenance projects on the Stream Maintenance Web site: (http://valleywater.org/EkContent.aspx?id=379&terms=stream+maintenance) 5. For high profile projects, at the District's discretion, signs will be posted in the neighborhood to notify the public at least one week in advance of maintenance schedules, trail closures, and road/lane closures as necessary and as possible. Signage used at work sites will include contact information for lodging comments and/or complaints regarding the maintenance activities.
GEN-37	Implement Public Safety Measures	<p>The District will implement public safety measures during maintenance as follows:</p> <ol style="list-style-type: none"> 1. Construction signs will be posted at job sites warning the public of construction work and to exercise caution,

BMP Number	BMP Title	BMP Description
		<p>as appropriate to public accessed areas.</p> <ol style="list-style-type: none"> 2. Where work is proposed adjacent to a recreational trail, warning signs will be posted several feet beyond the limits of work. Signs will also be posted if trails will be temporarily closed. 3. If needed, a lane will be temporarily closed to allow for trucks to pull into and out of access points to the work site. 4. Temporary fencing, either the orange safety type or chain link, will be installed above repair sites on bank stabilization projects. 5. When necessary, District or contracted staff will provide traffic control and site security.
GEN-38	Minimize Noise Disturbances to Residential Areas	<p>The District will implement maintenance practices that minimize disturbances to residential areas surrounding work sites.</p> <ol style="list-style-type: none"> 1. With the exception of emergencies, work will be conducted during normal working hours. Maintenance activities in residential areas will not occur on Saturdays, Sundays, or District observed holidays except during emergencies, or with approval by the local jurisdiction and advance notification of surrounding residents. 2. Vehicles, generators and heavy equipment will be equipped with adequate mufflers. 3. Idling of vehicles will be prohibited beyond 5 minutes unless operation of the engine is required to operate a necessary system such as a power take-off (PTO).
GEN-39	Planning for Pedestrians, Traffic Flow, and Safety Measures	<ol style="list-style-type: none"> 1. Work will be staged and conducted in a manner that maintains two-way traffic flow on public roadways in the vicinity of the work site. If temporary lane closures are necessary, they will be coordinated with the appropriate jurisdictional agency and scheduled to occur outside of peak traffic hours (7:00 – 10:00 a.m. and 3:00 – 6:00 p.m.) to the maximum extent practicable. Any lane closures will include advance warning signage, a detour route and flaggers in both directions. When work is conducted on public roads and may have the potential to affect traffic flow, work will be coordinated with local emergency service providers as necessary to ensure that emergency vehicle access and response is not impeded. 2. Bicycle and pedestrian facility closures will be scheduled outside of peak traffic hours (7:00 – 10:00 a.m. and 3:00 – 6:00 p.m.) to the maximum extent practicable. 3. Public transit access and routes will be maintained in the vicinity of the work site. If public transit will be affected by temporary road closures and require detours, affected transit authorities will be consulted and kept informed of project activities. 4. Adequate parking will be provided or designated public parking areas will be used for maintenance-related vehicles not in use through the maintenance period. 5. Access to driveways and private roads will be maintained. If brief periods of maintenance would temporarily block access, property owners will be notified prior to maintenance activities.

BMP Number	BMP Title	BMP Description
Cultural Resources		
GEN-40	Discovery of Cultural Remains or Historic or Paleontological Artifacts	<p>Work in areas where remains or artifacts are found will be restricted or stopped until proper protocols are met.</p> <ol style="list-style-type: none"> 1. Work at the location of the find will halt immediately within 50 feet of the find. A “no work” zone shall be established utilizing appropriate flagging to delineate the boundary of this zone, which shall measure at least 50 feet in all directions from the find. 2. The District shall retain the services of a Consulting Archaeologist or Paleontologist, who shall visit the discovery site as soon as practicable, and perform minor hand-excavation to describe the archaeological or paleontological resources present and assess the amount of disturbance. 3. The Consulting Archaeologist shall provide to the District and the Corps, at a minimum, written and digital-photographic documentation of all observed materials, utilizing the guidelines for evaluating archaeological resources for the California Register of Historic Places (CRHP) and National Register of Historic Places (NRHP). Based on the assessment, the District and Corps shall identify the CEQA and Section 106 cultural-resources compliance procedure to be implemented. 4. If the find appears to not meet the CRHP or NRHP criteria of significance, and the Corps archaeologist concurs with the Consulting Archaeologist’s conclusions, construction shall continue while monitored by the Consulting Archaeologist. The authorized maintenance work shall resume at the discovery site only after the District has retained a Consulting Archaeologist to monitor and the Watershed Manager has received notification from the Corps to continue work. 5. If the find appears significant, avoidance of additional impacts is the preferred alternative. The Consulting Archaeologist shall determine if adverse impacts to the resources can be avoided. 6. When avoidance is not practical (e.g., maintenance activities cannot be deferred or they must be completed to satisfy the SMP objective), the District shall develop an Action Plan and submit it to the Corps within 48 hours of Consulting Archaeologist’s evaluation of the discovery. The action Plan may be submitted via e-mail to {rstradford@spd.usace.army.mil}. The Action Plan is synonymous with a data-recovery plan. It shall be prepared in accordance with the current professional standards and State guidelines for reporting the results of the work, and shall describe the services of a Native American Consultant and a proposal for curation of cultural materials recovered from a non-grave context. 7. The recovery effort will be detailed in a report prepared by the archaeologist in accordance with current archaeological standards. Any non-grave artifacts will be placed with an appropriate repository. 8. The Consulting Paleontologist will meet the Society for Vertebrate Paleontology’s criteria for a “qualified professional paleontologist” (Society of Vertebrate Paleontology Conformable Impact Mitigation Guidelines Committee 1995). 9. The paleontologist will follow the Society for Vertebrate Paleontology’s guidelines for treatment of the artifact. Treatment may include preparation and recovery of fossil materials for an appropriate museum or university collection, and may include preparation of a report describing the finds. The District will be responsible for ensuring that paleontologist’s recommendations are implemented. 10. In the event of discovery of human remains (or the find consists of bones suspected to be human), the field crew supervisor shall take immediate steps to secure and protect such remains from vandalism during periods when work crews are absent.) 11. Immediately notify the Santa Clara County Coroner and provide any information that identify the remains as Native American. If the remains are determined to be from a prehistoric Native American, or determined to be a Native American from the ethnographic period, the Coroner shall contact the Native American Heritage

BMP Number	BMP Title	BMP Description
		<p>Commission (NAHC) within 24 hours of being notified of the remains. The NAHC then designates and notifies within 24 hours a Most Likely Descendant (MLD). The MLD has 24 hours to consult and provide recommendations for the treatment or disposition, with proper dignity, of the human remains and grave goods.</p> <p>12. Preservation in situ is the preferred option. Human remains shall be preserved in situ if continuation of the maintenance work, as determined by the Consulting Archaeologist and MLD, will not cause further damage to the remains. The remains and artifacts shall be documented and the find location carefully backfilled (with protective geo-fabric if desirable) and recorded in District project files.</p> <p>13. Human remains or cultural items exposed during maintenance that cannot be protected from further damage shall be exhumed by the Consulting Archaeologist at the discretion of the MLD and reburied with the concurrence of the MLD in a place mutually agreed upon by all parties.</p>
GEN-41	Review of Projects with Native Soil	<p>A cultural resources specialist will conduct a review and evaluation of those sites that would involve disturbance / excavation of native soil previously undisturbed by contemporary human activities to determine their potential for affecting significant cultural resources. The evaluation of the potential to disturb cultural resources will be based on an initial review of archival information provided by the California Historical Resources System/Northwest Information Center (CHRIS/NWIC) in regard to the project area based on a 0.25 mile search radius. It is recommended that this initial archival review be completed by a professional archaeologist who will be able to view confidential site location data and literature to arrive at a preliminary sensitivity determination. If necessary, a further archival record search and literature review (including a review of the Sacred Lands Inventory of the Native American Heritage Commission); and a field inventory of the project area will be conducted to determine the presence/absence of surface cultural materials associated with either prehistoric or historic occupation. The results along with any mitigation and/or management recommendations would be presented in an appropriate report format and include any necessary maps, figures, and correspondence with interested parties. A summary table indicating appropriate management actions (e.g., monitoring during construction, presence/absence testing for subsurface resources; data recovery, etc.) will be developed for each project site reviewed. The management actions will be implemented on site to avoid significant effects to cultural resources.</p>

Utilities

GEN-42	Investigation of Utility Line Locations	<p>An evaluation of the locations of utility lines that could be affected by maintenance activities will be conducted annually as part of the preparation of the Notice of Proposed Work (NPW). Utilities will be avoided as much as possible. For maintenance areas with the potential for adverse effects on utility services, the following measures shall be implemented:</p> <ol style="list-style-type: none"> 1. Utility excavation or encroachment permits shall be required from the appropriate agencies. These permits include measures to minimize utility disruption. The District and its contractors shall comply with permit conditions. Such conditions shall be included in construction contract specifications. 2. Utility locations shall be verified through a field survey (potholing) and use of the Underground Service Alert services. 3. Detailed specifications shall be prepared as part of the design plans to include procedures for the excavation, support, and/or fill of areas around utility cables and pipelines. All affected utility services shall be notified of the District's maintenance plans and schedule. Arrangements shall be made with these entities regarding protection, relocation, or temporary disconnection of services. 4. Residents and businesses in the project area shall be notified of planned utility service disruption 2 to 4 days in advance, in conformance with state standards. 5. Disconnected cables and lines shall be reconnected promptly.
--------	---	---

B. SECTION B – Sediment Removal BMPs

This group of BMPs is intended to be implemented specifically during sediment removal activities to avoid potential impacts on biological resources.

BMP Number	BMP Title	BMP Description
SED-1	Groundwater Management	If high levels of groundwater (i.e., visible water) are encountered during excavations in a work area, the water will be pumped out of the work site or left within the work area if the work activity is not causing water quality degradation in a live stream. Water Quality monitoring would need to occur. If necessary to protect water quality, the extracted water will be discharged into specifically constructed infiltration basins, holding ponds, or areas with vegetation to remove sediment prior to the water re-entering a creek. Water discharged into vegetated areas or swales will be pumped in a manner that will not create erosion around vegetation.
SED-2	Prevent Scour Downstream of Sediment Removal	Sediment removal sites in the transport zone on alluvial fans may cause increased scour downstream if they experience scouring flows or rapid sediment accumulation after maintenance. After sediment removal, the channel will be graded so that the transition between the existing channel both upstream and downstream of the maintenance area is smooth and continuous between the maintained and non-maintained areas and does not present a sudden vertical transition (wall of sediment) or other blockage that could erode once flows are restored to the channel.
SED-3	Restore Channel Features	Low-flow channels within non-tidal streams will be contoured to facilitate fish passage and will emulate the pre-construction conditions as closely as possible, within the finished channel topography.
SED-4	Berm Bypass	Where sediment removal is accomplished without a bypass by removing alternating cells, the berm between the work and the live channel will be wide enough to prevent introduction of turbid water from the cell into the live channel.
SED-5	Sediment Characterization	Projects involving sediment removal at stream gauges, outfalls, culverts, flap gates, tide gates, grade control structures, bridges, fish ladders, and fish screens in excess of 25 cubic yards shall be characterized in accordance with the SCVWD's Sediment Characterization Plans for SMP-2. These projects shall be reported in the annual summary report. Sediment removed will not be reused without pre-approval from appropriate regulatory agencies. See section 5.4 for information on the waiver process.

C. SECTION C – Vegetation Management BMPs

These BMPs provide specific and detailed guidance on the variety of vegetation management procedures implemented by the District. BMPs for the following maintenance techniques are included: tree pruning, tree removal, plant removal, woody debris management, herbicide application, mowing, discing, flaming, and grazing. Practices will be implemented by fully trained and qualified field crews.

BMP Number	BMP Title	BMP Description
VEG-1	Minimize Local Erosion Increase from In-channel Vegetation Removal	To minimize the potential effect of localized erosion, the toe of the bank will be protected by leaving vegetation to the maximum extent possible and consistent with the maintenance guidelines or original design requirements.
VEG-2	Non-native Invasive Plant Removal	Invasive species (e.g. cape ivy [<i>Delairea odorata</i> / <i>Senecio mikanooides</i>], arundo [<i>Arundo donax</i>]) will be disposed of in a manner that will not contribute to the further spread of the species. Cape ivy removed during a project shall be bagged and disposed of in a landfill. Arundo canes will be prevented from floating downstream or otherwise entering the creek or waterway.
VEG-3	Use Appropriate Equipment for Instream Removal	When using heavy equipment to cut or remove instream vegetation, low ground pressure equipment, such as tracked wheels will be utilized to reduce impacts to the streambed.
VEG-4	Use Flamers with Caution	<ol style="list-style-type: none"> 1. A fire extinguisher, water supply and other appropriate fire suppression equipment will always be kept close to the work site in case of an emergency. 2. Propane tanks will be checked for leaks and proper functioning prior to and proceeding use of flaming equipment. The propane tank will be treated as a hazardous material.
VEG-5	Conduct Flaming During Appropriate Weather and Seasonal Conditions	Flamers will not be used during periods of high fire danger or in areas where fuel or climate conditions could accidentally ignite a fire.
VEG-6	Standard Grazing Procedures	<ol style="list-style-type: none"> 1. Vegetation and areas to be preserved will be fenced off to exclude grazing animals. 2. Grazing animals will be excluded from stream channels, using fencing or other barriers.

D. SECTION D – Bank Stabilization BMPs

These BMPs provide additional guidance during implementation of bank stabilization projects to avoid impacts on biological and cultural resources. Review of the Post-Project Restoration BMPs in Section F is recommended because those measures will be implemented after bank stabilization projects are complete. The BMPs included in this section are implemented by the field crew and site manager.

BMP Number	BMP Title	BMP Description
BANK-1	Bank Stabilization Design to Prevent Erosion Downstream	To further prevent potential downstream erosion impacts due to bank stabilization, the site design will be adjusted to provide proactive protection of vulnerable areas within the reach of the worksite. Such measures include, but are not limited to, appropriately keyed-in coir logs, riparian planting, strategic placement of rock, and flow deflectors. Bank stabilization will include appropriate transition designs upstream and downstream of the work site to prevent potential erosion impacts.
BANK-2	Concrete Use Near Waterways	Concrete that has not been cured is alkaline and can increase the pH of the water. Fresh concrete will be isolated until it no longer poses a threat to water quality using the following appropriate measures: <ol style="list-style-type: none"> 1. Wet sacked concrete will be excluded from the wetted channel for a period of 30 days after installation. During that time, the wet sacked concrete will be kept moist (such as covering with wet carpet) and runoff from the wet

BMP Number	BMP Title	BMP Description
		<p>sacked concrete will not be allowed to enter a live stream.</p> <p>2. Poured concrete will be excluded from the wetted channel for a period of 30 days after it is poured. During that time, the poured concrete will be kept moist, and runoff from the wet concrete will not be allowed to enter a live stream. Commercial sealants (e.g., Deep Seal, Elasto-Deck Reservoir Grade) may be applied to the poured concrete surface where difficulty in excluding water flow for a long period may occur. If a sealant is used, water will be excluded from the site until the sealant is dry.</p> <p>3. Dry sacked concrete will not be used in any channel.</p> <p>4. An area outside of the channel and floodplain will be designated to clean out concrete transit vehicles.</p>
BANK-3	Bank Stabilization Post-Construction Maintenance	<p>The District may maintain or repair bank stabilization projects that are less than 2 years old that are damaged by winter flows.</p> <p>The District will notify the regulatory agencies 24 hours prior to beginning the work and the work will be reported as part of the Post-Construction Report submitted by January 15 of each year or if necessary, the subsequent year.</p> <p>Appropriate BMPs will be applied during maintenance repairs.</p>

E. SECTION E – Post-Project Restoration BMPs

These BMPs will be implemented, as appropriate, on all sites that involve ground disturbance.

BMP Number	BMP Title	BMP Description
REVEG-1	Seeding	<p>Sites where maintenance activities result in exposed soil will be stabilized to prevent erosion. Disturbed areas shall be seeded with native seed as soon as is appropriate after maintenance activities are complete. An erosion control seed mix may be applied to exposed soils, and down to the ordinary high water mark (OHWM).</p> <p>1. The seed mix should consist of California native grasses (e.g., <i>Hordeum brachyantherum</i>, <i>Elymus glaucus</i>, and <i>Vulpia microstachydes</i>) or annual, sterile seed mix.</p> <p>2. Temporary earthen access roads may be seeded when site and horticultural conditions are suitable, or have other appropriate erosion control measures in place (GEN-20).</p>
REVEG-2	Planting Material	<p>Revegetation and replacement plantings will consist of locally collected native species. Species selection will be based on surveys of natural areas on the same creek that have a similar ecological setting and/or as appropriate for the site location.</p>

F. SECTION F – Management of Animal Conflict BMPs

Methods of animal management included in the SMP are avoidance, biological controls, physical alterations, habitat alterations, and lethal controls. Of all these methods, implementation of lethal controls has the highest potential for environmental and biological impacts. Therefore, the animal management BMPs provided in this section focus on lethal controls. The application area for lethal controls will be identified during the annual planning process (see the Biological Resource Planning BMPs) and guided as directed by wildlife biologists. Species habitat areas are defined by the District’s GIS species mapping, updated CNDDDB and known local biological information and are included in the SMP Update Subsequent EIR.

BMP Number	BMP Title	BMP Description
ANI-1	Avoid Redistribution of Rodenticides	<p>Carcass surveys will be conducted periodically when acute poisons and first generation anticoagulants are used. The frequency of the carcass surveys will be specific to the type of rodenticide used, to minimize secondary poisoning impacts:</p> <ul style="list-style-type: none"> • Acute toxins – Daily carcass surveys, beginning the first day after application until the end of the baiting period for acute toxins used above-ground. • Anticoagulants - Within 7 days of installation of first generation anticoagulant bait, and weekly thereafter. Anytime a carcass is found, daily carcass surveys will begin for as long as carcasses are found until no carcasses are found during a daily survey. Once no carcasses are found, carcass surveys will return to the weekly carcass survey timeline maximum from the date of initial installation of an anticoagulant bait station. <p>To verify that the frequency of carcass surveys is adequate, a biologist will conduct daily carcass surveys 2 times per year over one baiting cycle. Based on the results of these surveys, the timing of carcass surveys will be adjusted if necessary.</p> <p>Any spilled bait will be cleaned up immediately.</p>
ANI-2	Prevent Harm to the Salt Marsh Harvest Mouse and California Clapper Rail	<ol style="list-style-type: none"> 1. No rodenticides or fumigants will be used within the range of the SMHM or CCR as identified on District range maps. 2. Methods of rodent control within SMHM or CCR habitat will be limited to live trapping. All live traps shall have openings measuring no smaller than 2 inches by 1 inch to allow any SMHM that inadvertently enter the trap to easily escape. All traps will be placed outside of pickleweed areas and above the high tide line.
ANI-3	Burrowing Owl, Bald Eagle and Golden Eagle Buffer Zone	<p>Per the California Department of Fish and Wildlife’s 2008 <i>Guidance for Burrowing Owl Conservation</i>, a 656-yard buffer will be established around known burrowing owl locations where no rodenticides or fumigants (including smoke bombs) will be used. A 0.5-mile buffer will be established around known bald eagle and golden eagle nesting locations where no rodenticides will be used.</p>
ANI-4	Animal Control in Sensitive Amphibian Habitat	<ol style="list-style-type: none"> 1. Fumigants will not be used within the habitat areas of special status amphibians. 2. The use of bait stations within the potential habitat areas of California red-legged frog, California tiger salamander, or foothill yellow-legged frog will be limited to bait stations specifically designed to prevent entry by these species. 3. Any live traps will allow California red-legged frogs, California tiger salamanders, or foothill yellow-legged frogs to safely exit (e.g., by having openings measuring no smaller than 2 inches by 1 inch).
ANI-5	Slurry Mixture near Waterways	<p>All slurry type mixes used to fill rodent burrows will be prevented from entering any waterway by using appropriate erosion control methods and according to the manufacturer’s specifications. If the creek bed is dry or has been dewatered, any material that has entered the channel will be removed.</p>
ANI-6	Species requiring depredation permit	<p>Animal Conflict Management will not include lethal control of species listed in California F&G Code Section 4181 including beaver and gray squirrel without first obtaining a depredation permit.</p>

G. SECTION G – Use of Pesticides

Pesticides may be used for vegetation management or control of animal damage.

BMP Number	BMP Title	BMP Description
HM-4	Posting and Notification for Pesticide Use	<p>Posting of areas where pesticides are used will be performed in compliance with District Policy Ad-8.2 Pesticide Use as follows:</p> <ol style="list-style-type: none"> 1. Posting will be performed in compliance with the label requirements of the product being applied. 2. In addition, posting will be provided for any products applied in areas used by the public for recreational purposes, or those areas readily accessible to the public, regardless of whether the label requires such notification. In doing this, the District ensures that exposure risk is minimized further by adopting practices that go beyond the product label requirements. (The posting method may be modified to avoid destruction of bait stations or scattering of rodenticide.) 3. These postings will notify staff and the general public of the date and time of application, the product's active ingredients, and common name, and the time of allowable re-entry into the treated area. 4. Signs will not be removed until after the end of the specified re-entry interval. 5. Right-to-know literature on the product will be made available to anyone in the area during the re-entry period. 6. A District staff contact phone number will be posted on the sign, including a cellular phone number. 7. Notification of pesticide activities will be made as required by law. Also, the District will maintain records of neighbors with specific needs relative to notification before treatment of an adjacent area so that such needs are met.

Source: Data compiled by Horizon Water and Environment in 2011

ATTACHMENT G

Sediment Characterization Plan

SEDIMENT CHARACTERIZATION PLAN

FOR THE
SANTA CLARA VALLEY WATER DISTRICT
MULTI-YEAR STREAM MAINTENANCE PROGRAM

Revised by

Ray Fields
Project Manager
Stream Maintenance Program Unit

Kristen O’Kane
Stream Maintenance Program Unit Manager
Stream Stewardship Unit

Under the Direction of

Chris Elias
Deputy Operating Officer
Watershed Operations and Maintenance Division

November 2013

TABLE OF CONTENTS

	Page
INTRODUCTION	3
PURPOSE	3
SCOPE	4
OBJECTIVES	4
SAMPLING METHODS	5
SAMPLE COLLECTION	7
SAMPLE CONTAINERS AND SAMPLE VOLUMES	8
DECONTAMINATION PROCEDURES	8
SAMPLE PRESERVATION	8
CHAIN OF CUSTODY PROCEDURES	8
SURVEY OF SAMPLING LOCATIONS	9
ANALYTICAL PROCEDURES	9
RATIONAL FOR ANALYTICAL TEST METHOD SELECTION	9
QUALITY CONTROL	10
LABORATORY	10

Introduction

The Santa Clara Valley Water District (District) conducts sediment removal, vegetation management, bank protection repairs, minor maintenance, and canal maintenance activities in channels/creeks for the purpose of alleviating the potential for local flooding problems and to meet the requirements of the Federal Emergency Management Agency for flood protection. Under the aforementioned activities of the Multi-Year Stream Maintenance Program (SMP), channel/creek sediment is often removed as a result of these activities. In order to effectively manage the removal and disposal of the sediments removed as a result of these activities, it is necessary to characterize the chemical and physical properties of the sediments (or also known as creek material as some of the tested material is from the creek banks or stockpiles, etc.). This characterization allows the District to (1) effectively plan for disposal of the sediments and (2) assist with determining the best management practices (BMP) to implement in order to avoid and minimize impacts to water quality, aquatic life, and Beneficial Uses as specified in the San Francisco and Central Coast Water Quality Control Boards' (Water Board) Basin Plans. The sediment characterization plan proposed for the District's SMP, as presented herein, is a result of the District's sediment testing and evaluation effort, and continuous improvement process based on guidance from regulatory agencies and other stakeholders, since 1997.

Purpose

According to the Basin Plans, the Water Boards establish and enforce Waste Discharge Requirements (WDRs) for point and nonpoint source of pollutants at levels necessary to meet numerical and narrative water quality objectives. The sediment tests performed by the District each year, as part of its SMP are based on the historic occurrence of pollutants within Santa Clara Valley streams, in accordance with the Basin Plans' water quality objectives, and the Water Boards' WDR through a stakeholder process. The stakeholder process and lessons learned meetings involved participation of the Water Boards, the California Department of Fish and Wildlife (DFW), the U.S. Environmental Protection Agency (EPA), the U.S. Army Corps of Engineers (Corps), and various environmental organizations which assisted the District in continuous evaluation and improvement of the sediment characterization plan.

There are four main reasons for characterizing the sediments described as follows:

Landfill Acceptance

Landfills require creek sediment to be characterized before they accept the material for disposal.

Reuse Sites

The evaluation of test results for the placement of excavated materials in beneficial reuse sites. The beneficial reuse options include wetland creation and restoration, levee maintenance, and construction fill. Material reused within the 500 feet upstream or downstream is done without sediment testing with prior approval by the Regional Water Board.

The San Francisco and Central Coast Regional Water Quality Control Boards

The Water Boards have required characterization of the materials to determine if the proposed disposal method is acceptable. The Water Boards must ensure that the disposal of the material will not pose a threat to the waters of the State. The Water Boards are interested in determination of total mercury and polychlorinated biphenyls (PCB's) in residual sediment after sediment removal.

The California Department of Fish and Wildlife

DFW requests that the materials be characterized to determine if they will adversely impact fish and wildlife as the removal operations may cause sediments to be re-suspended and migrate downstream where it may have an impact on fish and wildlife. DFW defers to the Water Boards for the determination of suitability for creek material removal.

Scope

Under the SMP, sediment will only be tested using the San Francisco Bay Regional Water Quality Control Board's Beneficial Reuse of Dredged Materials: Sediment Screening and Testing Guidelines (May 2000) to facilitate any beneficial reuse of sediment generated by the District. The physical and chemical properties of sediments tested by the District include metals, pesticides and organophosphorous compounds, polychlorinated biphenyls, polynuclear aromatic hydrocarbons, moisture content, chloride, pH, total sulfides, ammonia, and toxicity (as described below).

This sampling plan documents sampling and analytical procedures which will be utilized for the creek sites under the SMP. It is not intended to be a full characterization of all the stream sediments. The Sediment Characterization Plan is primarily designed to characterize sediment designated for removal (using composite, continuous core and residual sediment sampling methods). Residual sediment samples will only be collected in an attempt to characterize the sediment that may be subject to erosion and transport during flows.

The Sediment Characterization Plan addresses the following sampling methods designed to meet the overall objectives of landfill acceptance, sediment reuse sites, water quality protection, and fish and wildlife protection:

1. Composite sediment sampling
2. Continuous Core sampling
3. Residual sediment sampling

Objectives

The specific objectives of the Sediment Characterization Plan are as follows:

1. Characterize the sediments for acceptance by landfills.
2. Characterize the sediments to determine their suitability for beneficial reuse (i.e., non-landfill reuse sites).

3. Compliance with regulatory requirements for the sediment removal activities.
4. Provide data for evaluation of the feasibility of long-term disposal, reuse, and recycling opportunities for sediment generated by the District.

Sampling Methods and Procedures

This section describes the frequency of sampling and the location of sample collection at the SMP sites involving sediment removal activities. From both the regulatory and scientific perspectives, the primary objectives of a sampling plan for a solid material are twofold: namely, (1) to collect samples that are representative samples as exhibiting average properties of the whole solid material and (2) to collect samples that will allow measurements of the chemical properties of the waste that are both accurate and precise.

Sediment samples will be collected for characterization of sediment designated for removal and analyzed in accordance with the contaminants listed on Table 4 Recommended Sediment Chemistry Screening Guidelines for Beneficial Reuse of Dredged Material (Re-use Guidelines) from the Water Board's Basin Plan. Sampling parameters/analytes listed in Table 4 may be modified after a history of sampling is obtained. This may result in not requiring monitoring for some of these contaminants under certain situations or at certain locations, or adding more parameters/analytes if deemed necessary by the Executive Officer of the Water Board.

Reliable information concerning the chemical properties of a solid waste is needed for the purpose of comparing chemical properties with applicable regulatory thresholds. For chemical information to be reliable, it must be accurate and precise. Accuracy is usually achieved by incorporating some form of randomness into the selection process for the samples that generate the data. Precision is most often obtained by selecting an appropriate number of samples.

For this Sediment Characterization Plan, the District will utilize a systematic random sampling technique generated by the sediment sampling database, in which all sampling points from a population are randomly selected. The advantages of systematic random sampling over other sampling techniques are the ease with which samples are identified, and collected, an increase in precision, and to collect representative data on chemical properties. All samples shall be collected in accordance with the most recent U.S. EPA Guidelines and sampling methodologies. The methods of analyses and detection limits must be appropriate for the expected concentrations. Specific methods of analyses must be identified. If methods other than U.S. EPA – approved methods of Standard Methods are used, the exact methodology must be submitted for review and approved by the Executive Officer of the Water Board.

The following techniques provide a general sampling approach and will suffice for most projects. Where these techniques would not provide a representative sample of the project area, Regional Board staff will be consulted to provide additional sampling direction.

Composite Sediment Samples

The purpose of composite sediment sampling is to conduct the widest range of characterization along the project sites' lengths and widths in order to capture the most variation of the area. This broader scope of randomly generated 4 point sampling will give a greater sense of the variability of the channel material than a specific sample point.

Composite Sample Collection Frequency

In order to characterize the sediment, one composite, which consists of 4 random samples, in-situ sample shall be collected and analyzed approximately every 4,000 cys. Approximately one sample shall be collected every 1,000 cys. These samples will be composited together by the laboratory. The length of the channel is also taken into consideration as the District's database will generate sampling points based on the length of the project area. As such, projects with long project lengths will have sample points farther apart in order to better characterize the variability in sediment contaminants along the entire length of the worksite.

Composite Sample Locations

The location of each sample at the Sediment Removal Program sites must be selected in the following three dimensions: (1) the creek station, or the location along the length of the creek; (2) the location along the creek cross section; and (3) the depth below ground surface (bgs). With these parameters, a sample point is randomly generated. The rationale for selection of a sampling location in all three dimensions is described below:

Composite Sample Depth

The sampling depth of the composite samples are also randomly generated varied from surface sampling to maximum excavation depth of the proposed project.

Continuous Core Sediment Samples

The purpose of continuous core sampling is to take samples at selected locations (e.g. below outfalls, depression areas of the creek, likely contaminated areas) where the highest likelihood of contamination exists in the project site. This type of sample is not taken on the banks (above the toe of the channel) nor from stockpiles, only from within toe to toe of the channel.

Continuous Core Sample Collection Frequency

One continuous core sample is taken every 4000 cubic yards per project site.

Continuous Core Sample Locations

The location of the sample is determined in the field upon attempting to locate areas of depression or outfalls within the project site. As these features are not always apparent, the location will sometimes have to be placed in the most likely areas of these features.

Continuous Core Sample Depth

The depth of the sample is randomly generated by the District's sediment sampling database and printed on the sediment sampling plan generated in the office and used out in the field.

Residual Sediment Samples

The purpose of residual sediment sampling is to conduct limited characterization of sediment left behind after sediment removal from earthen channels and creeks. The exposed sediment in the channel/creek bottom will only be sampled and analyzed for total mercury and PCB.

Residual Sample Collection Frequency

Residual sediment samples will be collected at one every 4000 cys on earthen channels.

Residual Sample Locations

This type of sample will be collected at each earthen channel/creek site. The location of the residual sample will coincide with the continuous core sample.

Residual Sample Depth

The samples will be collected from within 1 foot below the planned maximum depth of excavation for that project.

Sample Collection

All samples shall be collected by means of a hand trowel, a hand auger, or another sampling method approved by the regulatory agencies. The individual collecting the sample will have the discretion of choosing the sampling method which is the most efficient to perform.

Sampling will be conducted in accordance with the methods described below:

Hand Trowel Procedure

1. Remove vegetation and woody debris from the ground surface.
2. If collecting a subsurface sample, use a shovel to dig down to the desired sampling interval.
3. Use a stainless-steel hand trowel to collect soil.
4. Place soil in an appropriate sampling container.
5. Replace all excavated soils to their original location (i.e., backfill the sampling hole).

Hand Auger Procedure

1. Remove vegetation and woody debris from the ground surface.
2. Use the hand auger to advance down to the top of the sampling interval.
3. Use a hand auger to collect soil from the desired depth.

4. Use a clean (decontaminated) tool to scoop the soil out of the auger and place in an appropriate sampling container.
5. Replace all excavated soils to their original location (i.e., backfill the sampling hole).
6. If hand auger refusal is encountered, sample will be collected from an alternate location.

Sample Containers and Sample Volumes

All samples shall be collected using wide-mouthed glass jars or other sampling containers as directed or supplied by the laboratory.

Sampling volume and number of containers necessary shall be specified by the District's contract of internal laboratory. It is anticipated that multiple containers of sediment will need to be collected at each location.

Decontamination Procedures

All equipment used to collect soil samples (hand trowel or hand auger) shall be decontaminated prior to collecting each sample, on-site. Equipment shall be decontaminated by at least rinsing the equipment twice with water, drying and then visually inspecting to ensure that there are no residual particles from the previous sample. The final rinse shall be with de-ionized or distilled water.

Sample Preservation

All samples shall be immediately preserved in accordance with the EPA sampling and testing procedures. This is most commonly done by placing the samples in an insulated cooler with ice. Samples may also be stored in a refrigerator.

The laboratory shall immediately record the temperature of the sample containers upon receipt of the samples, if required by the EPA sampling and testing procedures for the contaminants that are being analyzed.

Chain of Custody Procedures

Standard chain of custody procedures shall be used throughout the sampling collection procedures. A chain of custody shall be prepared for all samples. Each individual who has responsibility for the samples is required to sign the chain of custody upon relinquishing the samples to another party. The receiving party taking custody of samples shall also sign the chain of custody form.

When in the field, samples shall always be in sight of the individual responsible for the samples, or the samples shall be stored within a locked vehicle. If the samples are stored in an office prior to delivery to the laboratory, the samples shall be stored in a secure location. Applicable sample storage and preservation procedures shall be followed.

Survey of Sampling Locations

All sampling locations will be identified by Geographic Information Stationing.

Analytical Procedures

Every sediment sample location, with the exception of residual samples, shall be sampled for the full list of parameters/analytes listed in Table 4 for the Reuse Guidelines. Sampling parameters/analytes listed in Table 4 may be modified after a history of sampling is obtained. This may result in not requiring monitoring for some of these contaminants under certain situations or at certain locations, or adding more parameters/analytes if deemed necessary by the Executive Officer.

Rational for Analytical Test Method Selection

The rationale used for selecting test methods is based largely on the laboratory's ability to meet the detection limit requirements of the Table 4. All methods are EPA standards but may vary from time to time (based on changes from the EPA). Although, the driving force behind the selection of the test methods will be Water Board's Re-use Guidelines.

Moisture Content

Sediments in creeks naturally contain moisture; moisture content may fluctuate during the year and is dependent on creek flows, groundwater elevation, and other local conditions. The moisture content of in-situ soils will be higher than the moisture content of excavated sediments, due to the natural process of evaporation and infiltration.

Analysis of moisture content is required for Class III landfill acceptance for wet soils. In addition, it is necessary to measure the moisture content in order to determine the dry weight concentrations of constituents within the sediment.

Selected Test Method and Frequency of Testing

All samples except residual sediment samples shall be analyzed for moisture content by EPA Method 160.3 or the most current prescribed method.

Toxicity

Creek sediments may be toxic due to nonpoint source pollutants which may have been deposited into the creeks. Toxicity is of concern if the sediment is to be reused. Sediment toxicity test will be conducted only on composite samples from sites where the waters may not be controlled during sediment removal operations due to tidal action; therefore toxicity sampling shall only be conducted on sediment removal projects which would not divert the water around the project site during excavation.

Selected Test Method and Frequency of Testing

All samples in tidal areas only, except residual sediment samples, shall be tested for toxicity by means of a toxicity screening bioassay, by the test method specified in California Code of Regulations, Title 22. The samples will be tested using *Eohaustorius estuarius* species, unless otherwise specified by the EPA.

Methyl-Mercury Testing

Past mining operations allowed mining tailing and debris discharge to some creeks and this has increased mercury levels in sediments and soils in those watersheds, specifically the Guadalupe Watershed.

Selected Test Method and Frequency of Testing

Only the following creeks will be required to have the additional analysis of methyl mercury be performed for all composite samples, in accordance with EPA 1630:

- Alamitos Creek
- Guadalupe Creek
- Guadalupe River
- Los Gatos Creek
- Randol Creek.

Quality Control

A QA/QC plan is an important component of a monitoring program involving extensive field sampling and laboratory analyses. The two objectives of the QA/QC plan are: 1) to provide a means of ongoing control and evaluation of the sampling and analysis procedures; and 2) to quantify data precision and accuracy for use in data interpretation. Duplicate samples are no longer required. The QA/QC plan will be followed in all phases of the monitoring program including sampling and validation reporting. QA/QC requirements are noted below.

The District will utilize a sampling contractor or internal staff to conduct field sampling. The assigned field staff and/or contractor will be responsible for managing all field sampling equipment. The actual assignment of sampling areas and analysis are given to the sampling staff by the Stream Maintenance Program Project Manager (PM). Verification of equipment, analysis, chain of custodies, etc. will also be conducted by the PM.

All equipment used for field sampling will be kept in good working order and as required, will be tested and/or calibrated before leaving the office. Verification of working order/calibration (if necessary) should be re-verified, visually, upon arrival at the site to ensure the instruments are in proper working condition.

Laboratory

Whichever laboratory is used to perform analysis under this sediment sampling plan, they must be certified by the State of California Department of Health Services under the Environmental Laboratory Accreditation Program. For sub-labs that are out of state, they must hold current certification in their state's accreditation program. Further, the contract lab is required to perform their own quality control tests with the results published in the final lab report.

Reporting

Upon receipt of the analytical results from the laboratory, the District will submit the results to the Water Board and request approval for reuse as described below.

The District shall attempt to compile the results in 2 to 3 submittals to the Water Board

1. For ease of review, only the contaminants that test above the Water Board's Table 4 detection limits will be reported to the Water Board.
2. The entirety of the results, for detected and non-detected, shall be maintained in the District's database and made available upon request. Further, the signed lab copy of the results shall be maintained for no less than 3 years by the District
3. For project site sediments that are going to landfill, the Water Board is only required to approve the removal of the material as the landfill will approve acceptance to their disposal facility.

Table 4: Recommended Sediment Chemistry Screening Guidelines for Beneficial Reuse of Dredged

ANALYTE	Wetland Surface Material		Wetland Foundation Material	
	Concentration	Decision Basis	Concentration	Decision Basis
METALS (mg/kg)				
Arsenic	15.3	Ambient Values	70	ER-M
Cadmium	0.33	Ambient Values	9.6	ER-M
Chromium	112	Ambient Values	370	ER-M
Copper	68.1	Ambient Values	270	ER-M
Lead	43.2	Ambient Values	218	ER-M
Mercury	0.43	Ambient Values	0.7	ER-M
Nickel	112	Ambient Values	120	ER-M
Selenium	0.64	Ambient Values		
Silver	0.58	Ambient Values	3.7	ER-M
Zinc	158	Ambient Values	410	ER-M
ORGANOCHLORINE PESTICIDES/PCBS (µg/kg)				
DDTS, sum	7.0	Ambient Values	46.1	ER-M
Chlordanes, sum	2.3	TEL	4.8	PEL
Dieldrin	0.72	TEL	4.3	PEL
Hexachlorocyclohexane, sum	0.78	Ambient Values		
Hexachlorobenzene	0.485	Ambient Values		
PCBs, sum	22.7	ER-L	180	ER-M
POLYCYCLIC AROMATIC HYDROCARBONS (µg/kg)				
PAHs, total	3,390	Ambient Values	44,792	ER-M
Low molecular weight PAHs, sum	434	Ambient Values	3,160	ER-M
High molecular weight PAHs, sum	3,060	Ambient Values	9,600	ER-M
1-Methylnaphthalene	12.1	Ambient Values		
1-Methylphenanthrene	31.7	Ambient Values		
2,3,5-Trimethylnaphthalene	9.8	Ambient Values		
2,6-Dimethylnaphthalene	12.1	Ambient Values		
2-Methylnaphthalene	19.4	Ambient Values	670	ER-M
2-Methylphenanthrene		Ambient Values		
3-Methylphenanthrene		Ambient Values		
Acenaphthene	26.0	Ambient Values	500	ER-M
Acenaphthylene	88.0	Ambient Values	640	ER-M
Anthracene	88.0	Ambient Values	1,100	ER-M
Benz(a)anthracene	412	Ambient Values	1,600	ER-M
Benzo(a)pyrene	371	Ambient Values	1,600	ER-M
Benzo(e)pyrene	294	Ambient Values		
Benzo(b)fluoranthene	371	Ambient Values		
Benzo(g,h,i)perylene	310	Ambient Values		
Benzo(k)fluoranthene	258	Ambient Values		
Biphenyl	12.9	Ambient Values		
Chrysene	289	Ambient Values	2,800	ER-M
Dibenz(a,h)anthracene	32.7	Ambient Values	260	ER-M
Fluoranthene	514	Ambient Values	5,100	ER-M
Fluorene	25.3	Ambient Values	540	ER-M
Indeno(1,2,3-c,d)pyrene	382	Ambient Values		
Naphthalene	55.8	Ambient Values	2,100	ER-M
Perylene	145	Ambient Values		
Phenanthrene	237	Ambient Values	1,500	ER-M
Pyrene	665	Ambient Values	2,600	ER-M

ATTACHMENT H

Water Quality Monitoring Plan

WATER QUALITY MONITORING PLAN

**FOR THE
SANTA CLARA VALLEY WATER DISTRICT
MULTI-YEAR STREAM MAINTENANCE PROGRAM
-SAN FRANCISCO REGION-**

Revised by

Ray Fields
Project Manager
Stream Maintenance Program

Kristin O'Kane
Unit Manager
Stream Maintenance Program

Under the Direction of

Chris Elias
Deputy Operating Officer
Watershed Stewardship Division

June 2014

TABLE OF CONTENTS

Introduction	2
Purpose	2
Scope	2
Definition of Terms	2
Specifications for Sampling and Analyses	3
Quality Assurance and Quality Control	8
Reporting	8

Introduction

The purpose of the Stream Maintenance Program (SMP) is to alleviate local flooding problems and to meet the requirements of the Federal Emergency Management Agency for flood protection. To ensure compliance with the San Francisco Bay Regional Water Quality Control Board's (Water Board) Waste Discharge Requirements (WDRs) field water quality parameters will be measured/observed by the Santa Clara Valley Water District (District) during SMP operations using active diversions, which include pH, turbidity, temperature and dissolved oxygen. This plan has been revised based on field conditions encountered during the years of operation of the SMP.

Purpose

The purpose of the Water Quality Monitoring Plan (Plan) is to verify and document compliance with the requirements and prohibitions established by the Water Board as specified in the WDRs. This includes field/data reporting forms, sample collection, and formal reports to the Water Board. A water quality monitoring report will be submitted to the Water Board and other agencies/organizations (if requested) after the completion of each year's active diversion operations, in accordance with the Water Board's WDRs.

Scope

The scope of this plan is to outline the process, means and verification of monitoring water quality during SMP projects that use active diversions for all 4 authorized types of construction (Bank Stabilization, Minor Maintenance, Vegetation Management and Sediment Removal).

Definition of Terms

Grab sample: an individual sample collected in a short period of time not exceeding 15 minutes. They are to be used primarily in determining compliance with effluent and receiving water limits. Grab samples only represent the condition that exists at the time the water and effluent are collected.

Point of discharge: the location point at which water diverted around the active site is discharged into **tidal or non-tidal** waters of the State.

Active site: the confine of a SMP activity occurring on a waterway in which a pump is being used to divert water around the project site.

Duly authorized representative: one who is

- a. Authorization is made in writing by a principal executive officer, or
- b. Authorization specifies either an individual or a position having responsibility for the overall operation of the regulated facility or activity (e.g., field supervisor, project manager, chief engineer).

Downstream discharge/Effluent water: the water that flows out of a diversion, the discharged water (passive or active diversion).

Upstream water: water from a river or stream that is being diverted around a project site, from the upper end of the project site.

Receiving water: any water body that actually or potentially receives surface or ground water at the point of discharge, which passes over, through, or under dredged sediment during placement, dewatering, settling/consolidation, and excavation/removal activities – the water body that receives the discharge.

Active diversion: any method of diverting water around a project site other than non-mechanical means.

Passive diversion: the method of diverting water around a project site using no mechanical means. As well, working in channel where the project is being conducted outside of the live stream because of a natural buffer, such as excavating in pockets of sediment, will be considered a passive diversion.

Specifications for Sampling and Analyses

The District will perform sampling and analyses in accordance with the following conditions and requirements included in the WDRs issued by the Water Board. Two types of data collection will be conducted at the sites - water quality observations and water quality analyses using field instruments. No laboratory analyses will be conducted.

Water Quality Standard Observations:

Standard observations of surface water conditions shall be conducted upstream and downstream of the active project area to visually detect impacts of the water diversion. The following standard observations of the receiving waters will be collected on every day of operation on the field reporting form (Appendix A):

1. Floating and suspended materials of waste origin (to include, but not limited to, oil, grease, or other material that may come from the diversion/project site) presence or absence and size of the affected area.
2. Discoloration and turbidity: description of color, source, distance of travel and wind direction.
3. Odor: presence or absence, characterization, source, distance of travel, and wind direction.
4. Hydrographic condition including: depth of water columns, sampling depths, time and height of corrected low and high tides.
5. Weather condition including: air temperature, wind direction and velocity (speed), and precipitation.

Water Quality Analysis using Field Instruments:

Water Quality Testing:

Water Quality data will be collected by direct immersion of the instrument probe into the water column, or directly immersed into collection apparatus. The sample will be immediately analyzed on site for constituents in Table 1. Samples shall be collected with accurately calibrated field measurement instrument(s) and the results logged.

Table 1

Constituents	Type of Sample	Units
Turbidity	Grab/Dip	NTUs
pH	Grab/Dip	Not Applicable
Dissolved Oxygen	Grab/Dip	mg/l
Temperature	Grab/Dip	Degrees Fahrenheit

Water Quality Testing Locations

Samples will be collected at a distance of 100 feet (or at a location that is most representative of the typical undisturbed condition) upstream of the beginning of the active diversion and 100 feet (or at a location that is most representative of surface water affected by the diversion) directly downstream from the point of discharge into the receiving water of the non-tidal sites. For tidal sites, water samples will be collected only at the point of discharge on the receiving waters (with no upstream collection). The samples will not be taken during a rainstorm event or subsequent runoff event. For sites that straddle both freshwater and tidal areas, tidal sampling protocol will be followed. Samples of the discharge from temporary storage sites (if utilized) are to be collected as near as possible to the point of discharge without compromising the safety of personnel. Wherever possible, the probes will collect data from 1 foot below the surface (tidal and non-tidal sites)

Water Quality Testing Frequency

At every active diversion site, water quality samples shall be collected at least twice daily. Each sample set collected at the upstream and downstream locations must be taken within no more than a half an hour of each other (unless limiting circumstance exists, such as creek access over long creek reaches).

Background Sampling (pre-construction baseline sampling):

Prior to the installation of an active diversion and/or its components, at least one (1) day of background water samples (two samples per day evenly spaced during working hours) will be collected from the established testing locations. If there is a change in stream conditions

(eg. storm event) while there is a shutdown of the active diversion, new baseline sampling shall be conducted.

Operational Sampling:

Water quality samples will be collected from the established testing locations at the active diversion sites, at least two samples per day, evenly spaced during the work hours, with the first sample collected no earlier than 1 hour after work has commenced each day.

Background Sampling (post-construction baseline sampling):

After the removal of an active diversion and/or its components (either/or when pumps are shutoff and water is reintroduced into the project site), at least one (1) day of background water samples (two samples per day evenly spaced during working hours) will be collected from the established testing location upstream of the planned placement of the active diversion. The samples will be representative of typical undisturbed conditions and will not be taken during a rainstorm or subsequent runoff event.

Stock Pile Sampling

Water draining from a temporary sediment stockpile will be sampled on every day that there is a discharge which enters into a live stream. Sampling will be conducted at all points of discharge/runoff. Stockpile(s) must meet SMP Best Management Practices and San Francisco Regional Water Quality Control Board – Permit Condition standards. The sample will be immediately analyzed on site for constituents in Table 1.

What is an Exceedance?

An exceedance is where the receiving (downstream) water quality sample result for constituent(s) analyzed on site show an exceedance of the upstream water sample results, as specified in Table 2.

TABLE 2

Parameter	Exceedance Limit
pH	>0.5 units deviation from background (upstream)
Dissolved Oxygen	minimum of 5.0 mg/l for tidal waters or non-tidal warm water Minimum 7.0 mg/l for non-tidal cold waters or no change if background <5.0 mg/l
Turbidity	Waters shall be free of changes in turbidity that cause nuisance or adversely affect beneficial uses. Increases from normal background light penetration or turbidity relatable to waste discharge shall not be greater than

	10 percent in areas where natural turbidity is greater than 50 NTU.
Temperature	The temperature of any cold or warm freshwater habitat shall not be increased by more than 5°F (2.8°C) above the natural receiving water temperature

What to do if there is an Exceedance

If any water quality monitoring sample results in an exceedance, then the District will implement the following process to correct the exceedance:

1. Upon discovery of an exceedance, the District shall identify the source of the exceedance and immediately implement procedures to correct the source of the exceedance. Equipment and supplies shall be on-site (or readily available nearby) that could be quickly deployed to provide additional filtration if turbidity is observed. These supplies may include the following options: bladders for settling, filter bags and pumps, silt filter dams, or silt barrier as appropriate depending on site conditions.
2. A report to the Water Board case manager shall be made by telephone of any exceedances of whatever origin immediately after it is discovered.
3. Confirmation samples will be taken within two (2) hours following the exceedance.
4. The District shall stop all work at the site for exceedances lasting longer than two hours. The District shall update the Water Board staff of site conditions and the corrective actions that are taken.
5. Sampling every 2 hours will continue until the exceedance has been corrected. All constituents will continue to be monitored.
6. If all exceedances have been eliminated within four (4) hours of confirmation, work may proceed at the site, and the Regional Board case manager will be notified.
7. Region 3 staff will be notified promptly, and in no case more than 24 hours, after the unauthorized discharge or water quality problem arises.
8. The District shall notify Region 2 Water Board staff in writing within five calendar days of all exceedances. An electronic mail report shall include the following information: time and date of incident, duration, estimate of discharge or bypass volume exceedance, and documentation of sampling results/observations determining compliance status. The report shall also include detailed discussion of reasons for non-compliance, and specific steps that were or will be taken to correct the failure and prevent it from reoccurring.

Exceedance Reporting

A report to the Executive Officer and Water Board case manager shall be made by telephone of any exceedances of whatever origin immediately after it is discovered. A written report shall be filed with the Water Board within five calendar days and shall include the following information:

- a. A map showing the location(s) of exceedances(s);
- b. Approximate flow rate;

- c. Nature of effects, i.e., all pertinent observations and analyses; and
- d. Corrective measures underway or proposed.

Records to be Maintained

Written reports, calibration and maintenance records, and other records shall be maintained by the District and accessible at all times. Records shall be kept at the District for a minimum of 5 years. This period of retention shall be extended during the course of any unresolved litigation regarding this exceedance or when requested by the Water Board. Records shall include notes and observations for each sample as follows:

- a. Identification of sampling site by creek name, cross street, and item number (if available from the annual reports).
- b. Date and time of sampling.
- c. Date and time analyses are started and completed and the name of person conducting analyses.
- f. Data and results of analyses and/or observations.

Records shall include a map or maps of the site showing the location of the project(s) and water sampling locations, coffer dams, discharge pipes, access ramps, etc.

Quality Assurance and Quality Control

The QA/QC portion of the WDRs is an important component of the Plan involving, at the core of compliance, quality assurance of field sampling. As such, this section describes the two major elements of the QA/QC plan which are (1) field sampling to ensure compliance with WDRs criteria and (2) reporting of that compliance.

District utilizes sampling contractors and/or internal staff to conduct water quality sampling for the SMP projects. These monitors will use District approved field sampling instruments and sampling equipment. As field sampling is the ultimate means of ensuring compliance with WDRs requirements, it is imperative to have operating procedures that show the field sampling is being conducted in a manner that will collect analysis in an accurate way. In order to do this, the following criteria must be followed:

1. All personnel conducting water quality monitoring must read the relevant SMP best management practices, this WDRs plan, the SFRWQCB Board Order (No. R2-2012-xxxx), and manufacture calibration/instruction manuals for all sampling instruments used.
2. The SMP Project Manger must train personnel conducting this activity on all aspects of water quality monitoring.
3. Verification document signed that the relevant documents have been read and additional training has occurred.

All this documentation will be held with the SMP Project Manager (PM), for a period of five years. Further, all equipment will be tested and calibrated, in accordance with the equipment's

manufacture requirements, at least once a week to ensure the instruments are in proper working condition.

The reporting of the compliance/non-compliance of each project meeting the WDRs criteria is captured in an end of season report that is submitted to the Water Board, see “Final Water Quality Monitoring Report, attachments to the WDR and the District’s SMP Program Manual”.

Reporting

Responsible Entity

The SMP PM is responsible for implementing this Plan as required in the WDRs issued by the Water Board for the SMP. The PM will evaluate the data for compliance with the requirements of the WDRs and will inform the Watershed Field Operations of any non-compliance event in order for them to take immediate corrective action.

Reports to the Water Board

Permit Exceedances

The District shall notify the Water Board staff in electronic mail within five calendar days of all exceedances. Written reports shall include time and date of incident, duration, estimate of discharge or bypass volume exceedances, and documentation of sampling results/observations determining compliance status. The report shall also include detailed discussions of reasons for non-compliance and specific steps that were or will be taken to correct the failure and prevent it from re-occurring.

Final Monitoring Report

Upon completion of active diversion activities, a draft annual monitoring report will be filed with the Water Board within 60 days of completion of all work, permitted activities end no later than December 31st.

The report will include:

1. Certification Statement
2. Introduction
3. Compliance Summary
4. Purpose and Scope
5. Description of Work Performed
6. Water Quality Sampling Data by Individual Site
7. Maps – County level showing where monitoring activities occurred

Embedded within these sections:

1. A transmittal letter which includes a summary of all violations of WDRs, any changes to the project design, and any unplanned

releases or failures that occurred during the active diversion operations.

2. The report shall provide: the magnitude of the releases or failures; any discharge limit exceedances; dates of all exceedances, cause of the failure, releases or other violations; any corrective actions taken or planned; and the dates of completion of corrective action.

Final Report

Within 30 days after receipt of agency comments on the draft report, a final monitoring report will be filed with the Water Board. The final report will be signed by the Chief Operating Officer of the Watersheds or a duly authorized representative of that person.

Field Reporting Forms

APPENDIX A

Field Observation Reporting Form

Site Information		
Site Name	Site Location	Date

Standard Observations			
<i>Weather</i>			
Air Temperature	Precipitation (Heavy/Light)	Wind Direction/Speed	
<i>Visual</i>			
Floating Suspended Materials	Turbidity/Discoloration	Water Depth	
<div style="display: flex; justify-content: space-between;"> Present Absent </div> If present, what is the suspected source?	<div style="display: flex; justify-content: space-between;"> Present Absent </div>	<div style="display: flex; justify-content: space-around;"> U/S D/S </div>	
If present, Site Foreman Notified? _____ Time/Name _____			
<i>Odor</i>			
Present Absent _____			
If present, describe suspected source and estimate of affected area (wind direction and travel distance)			
If present, Site Foreman Notified? _____ Time/Name _____			
<i>Flow (FOR NON TIDAL SITES)</i>			
Estimated rate (cubic feet per second)			
<i>Tides (FOR TIDAL SITES) from NOAA tide chart</i>			
Time	Height		

ATTACHMENT I

Steelhead Impact Minimization Measures

ATTACHMENT I

Steelhead Impact Minimization Measures

The following measures will be applied to sediment removal and bank stabilization projects that occur in anadromous salmonid channels. These measures will be performed in the anadromous salmonid streams within the SMP area (Table 1).

Table 1. Anadromous salmonid creeks within the Stream Maintenance Program area.

Alamitos Creek	Little Arthur Creek ¹	San Francisquito Creek
Arroyo Aguague ¹	Llagas Creek	South Fork Pacheco Creek ¹
Bodfish Creek	Los Gatos Creek	Stevens Creek
Calero Creek	Los Trancos Creek ¹	Tar Creek ¹
Cedar Creek ¹	Pacheco Creek ¹	Upper Penitencia Creek
Coyote Creek	Pajaro River	Uvas/Carnadero Creek
Guadalupe River/Creek	Pescadero Creek ¹	

¹ Although work is not expected on these creeks, they are within the SMP project area and are therefore included here.

1. Mitigation Site Identification

1.1 Coarse Sediment Augmentation Site Identification

During the first 2 years of SMP-2, the SCVWD will collaborate with the resource agencies to conduct a survey of potential locations for gravel augmentation in each of the following salmonid occupied watersheds: Alamitos Creek, Guadalupe Creek, Los Gatos Creek, Guadalupe River, Upper Penitencia Creek, Coyote Creek, Stevens Creek, and San Francisquito Creek. Based on this survey, the SCVWD will develop a list of coarse sediment augmentation sites. The SCVWD will then prepare design plans in collaboration with the resource agencies. Sites for coarse sediment augmentation may be combined with instream habitat mitigation sites. The resource agencies may approve any or all of the projects on the list. The SCVWD may supplement the approved list at any time, pending the approval of the resource agencies. Sites for coarse sediment augmentation may occur in locations where finer sediments need to be removed.

1.2 Instream Habitat Complexity Mitigation Site Identification

During the first 2 years of SMP-2, the SCVWD will collaborate with the resource agencies to conduct a survey of potential locations for instream habitat complexity in each of the following salmonid occupied watersheds: Alamitos Creek, Guadalupe Creek, Los Gatos Creek, Guadalupe River, Upper Penitencia Creek, Coyote Creek, Stevens Creek, and San Francisquito Creek. Based on this survey, the SCVWD will develop a list of instream habitat complexity sites. The SCVWD will then prepare 50-90 percent design plans in collaboration with the resource agencies. Sites for instream habitat complexity may be combined with coarse sediment augmentation mitigation sites. The resource agencies may approve any or all of the projects on the list. The SCVWD may supplement the approved list at any time, pending the approval of the resource agencies.

1.3 Mitigation Plan Elements

The SCVWD in collaboration with the resource agencies will develop mitigation designs for off-site coarse sediment augmentation and instream habitat complexity projects. Coarse sediment augmentation and instream habitat complexity features may be combined into the same project. The mitigation designs will include the objectives for each project. The specific information included in the mitigation designs will include: affected watershed, location (stream, reach), pre-project site assessment, methods for coarse sediment placement, timing of coarse sediment placement, dewatering plan (if needed), proposed success criteria, and a monitoring plan. The monitoring plan will establish the type of monitoring to be conducted, the timing of the monitoring to be conducted, the duration of the monitoring to be conducted and adaptive management alternatives if the success criteria are not met. The SCVWD will include off-site coarse sediment augmentation projects and instream habitat complexity sites in the NPW prior to implementation.

For projects where coarse sediment replacement occurs on-site, the SCVWD will develop mitigation designs which include all of the components listed above. These on-site coarse sediment replacement and instream complexity projects will be submitted in the NPW for review and approval by the agencies. Mitigation proposed on-site or within sites closer to the project impact site, are desirable as they provide direct instream benefits closer to the area of impact and are therefore replacing loss features within a similar channel reach in which they have been displaced. This provides a higher level of benefit to the species within that reach of channel. Sites will not be chosen for coarse sediment augmentation if sediment removal is anticipated to occur more than twice in the 10-year SMP-2.

2 Coarse Sediment Augmentation

2.1 Project Assessments

2.1.1 Pre-project Coarse Sediment Assessment

The qualified biologist will conduct a surface assessment of the affected reach of channel to determine the location and quantity of coarse sediment (gravel and cobble [12.5 to 250 mm in diameter]) that may be removed by the proposed project. Patches of coarse sediment equal to or greater than 10 square feet, 0.5 foot thick, and containing more gravel than sand, will be mapped with GPS coordinates and the surface area measured. For coarse substrate within the project site, a map, diagram (i.e., hand sketch), or table will be prepared indicating the number and location of coarse sediment patches within the channel project site. Photographs of the project site will be taken to show the patches of coarse sediment areas. Patches of coarse sediment meeting the measurements stated above, will be multiplied by 1.5 feet to calculate the volume of coarse substrate to be mitigated. The pre-project assessment results will be submitted in the NPW.

Assessments will not be conducted at sediment removal projects at fish ladders, stream gauges, Sediment Depositional Reaches (SDRs), outfalls, or at sediment removal sites needed for fish passage.

2.1.2 Post –project Coarse Sediment Assessment

At the completion of the sediment removal project a qualified biologist will conduct a post-project assessment of the surface gravels within the project area using the same methods as the pre-

project assessment. Patches of coarse sediment equal to or greater than 10 square feet, 0.5 foot thick, and containing more gravel than sand, will be mapped with GPS coordinates and the surface area measured. For coarse substrate within the project site, a map, diagram (i.e., hand sketch), or table will be prepared indicating the number and location of coarse sediment patches within the channel. The coarse sediment area remaining onsite will be multiplied by 1.5 to determine the amount of available sediment remaining onsite. Photographs of the project site will be taken to show the patches of coarse sediment areas and will be submitted in the Annual Summary Report (ASR).

2.2 Impact Calculations

2.2.1 Coarse Sediment Removal Impact

The volume of sediment calculated in 2.1.1 will be the estimated volume of coarse sediment needed for mitigation for each sediment removal project. Each sediment removal project within individual watersheds will be added together to determine the amount of coarse sediment mitigation required for that watershed. The SCVWD will then select sites from the list of coarse sediment augmentation sites, or newly proposed sites, to meet the quantity of coarse sediment needed to offset the debt.

The estimated volume of coarse sediment required for mitigation may decrease based upon the post-project assessment. Where the areas of sediment removal is less than indicated in the pre-project assessment, the volume of coarse sediment in the areas of sediment not removed will be subtracted from the debt calculation. Where coarse sediment remains in areas where sediment was removed, the volume of sediment will be considered a watershed enhancement. At the end of the season, the coarse sediment debts in each watershed will be added up and the volume of coarse sediments not removed will be subtracted from the volume of sediment placed at augmentation sites. Where the SCVWD has placed more coarse sediments than it removed, the difference will be credited to the SCVWD in subsequent years.

2.3 Coarse Sediment Mitigation and Monitoring

2.3.1 Coarse Sediment Augmentation

To mitigate for the loss of coarse sediment, the SCVWD, in the NPW, will propose to augment coarse sediment at one or more of the sites on the approved coarse sediment augmentation list. The SCVWD may propose to add sites to the approved list at any time. Additional sites will be reviewed and approved by the resource agencies. In addition, the SCVWD may propose to use sediment removal sites for coarse sediment augmentation provided all the elements listed in section 1.3 are included in the submittal. All sites proposed for gravel augmentation will be included in the NPW. The sites selected for mitigation, either from the coarse sediment augmentation site list or as proposed in the annual NPW, will be in the same watershed where the impact occurs. The amount of coarse sediment augmentation will be commensurate with the volume of coarse sediment removed from the watershed that year. Mitigation may be provided prior to or within a year from the removal of coarse sediment.

2.3.2 Monitoring Coarse Sediment Augmentation

Sites used for coarse sediment augmentation will be monitored according to the monitoring plan described in the approved design plans and submitted in the NPW for review.

3 Instream Habitat Complexity Features Requirements

3.1 Instream Habitat Complexity Feature Assessments

3.1.1 Pre-Project Assessment of Instream Habitat Complexity Features.

A habitat assessment will be conducted at sediment removal sites that occur below the bankfull elevation and at bank stabilization sites on salmonid streams. The habitat assessment will be conducted by a qualified biologist during the late winter or spring months. Habitat complexity features may include the following:

1. Channel bed area with large cobble (defined as substrate with a medium diameter of 6 to 12 inches).
2. Boulders (defined as substrate with medium diameter of 12 inches or greater)
3. Shrub or tree root mass
4. Tree branches or collection of floating and submerged branches/vegetation (branches with diameter less than 12 inches, any length)
5. Large woody debris (greater than 12 inches in diameter, any length)
6. Undercut bank
7. Surface turbidity/bubble curtain

If the site is a perennial stream or contains water during the survey the qualified biologist will conduct a level 3 Habitat Typing (Flosi et al., 2010) methods. The habitat assessment area will include the entire proposed project site and extend upstream and downstream 5 times the in-channel width, or up to a maximum of 300 feet. The habitat complexity assessment will be conducted during the late winter or spring of the year. For habitat complexity features within the project site, a map, diagram (i.e., hand sketch), or table will be prepared listing each of the habitat features, the surface area, location and function. This includes all features within the SMP project site, both those that are expected to be impacted by the SMP activity and those not expected to be impacted. Photographs will also be taken of the site and features. The pre-project assessment results will be submitted in the NPW. If the site does not contain flowing water during the survey, a SCVWD biologist will assess the length of the project site to identify the above habitat complexity features.

Assessments will not be conducted at sediment removal projects at fish ladders, stream gauges, Sediment Depositional Reaches (SDRs), outfalls, or at sediment removal sites needed for fish passage.

3.1.2 Post-project Habitat Complexity Features Assessment for Sediment Removal

Post project habitat complexity assessments for sediment removal will use the same methods as the pre-project assessment.

3.1.3 Post-project Habitat Complexity Features Assessment for Bank Stabilization Projects

A post project assessment will be conducted by a qualified biologist using level 3 Habitat Typing (Flosi et al., 2010) methods. The habitat assessment area will be conducted along the length of the project site. The post project assessment will include sufficient documentation to determine the retention or loss of the pre-project habitat complexity. The post-project survey will also present all habitat/bioengineering features of the bank stabilization project that have been constructed to benefit aquatic habitat at the project site. A diagram (i.e., hand sketch) and photographs will be taken of the site and used to illustrate the conditions. The post-project

assessment report will include a table identifying the habitat complexity feature, the surface area, location, and function of the habitat features on-site.

3.2 Determination of the Extent of Impact and Mitigation Requirement

3.2.1 Instream Habitat Complexity Feature Impacts from Bank Stabilization and Sediment Removal Projects.

If the pre-project survey indicates the potential loss of instream habitat complexity features, the surface area of the features, type of features, the location of the features in the channel and other characteristics will be used to estimate the area and value of features to be impacted.

3.2.2 Instream Habitat Complexity Features Mitigation For Sediment Removal

To mitigate for the loss of the instream complexity features, the SCVWD will propose to construct one or more habitat mitigation projects from the list of projects described in section 1. above for each watershed where there are SMP project impacts. The habitat value of the mitigation projects installed within each watershed will be commensurate with the habitat value of the features anticipated to be impacted that year. Mitigation may be provided prior to or within a year from the removal of instream habitat complexity features.

Where the post-project assessment identifies instream habitat complexity features that may be impacted by the project, the post project assessment will identify the features that remain on-site following construction. The value of habitat complexity features remaining on-site following construction will be used to offset the value of mitigation required.

3.2.3 Instream Habitat Complexity Features Mitigation For Bank Stabilization Projects

The proposed bank stabilization design must incorporate, at minimum, habitat enhancement features to compensate for the loss of pre-project habitat complexity features. Since most bank stabilization projects are proposed at sites with active erosion, the project sites commonly have exposed soil with little to no vegetation. It is expected that SMP bank stabilization projects will generally be designed with bioengineering methods that have the ability to address both bank protection and restore habitat values to the sites' pre-erosion conditions. It is not sufficient for the SMP project design to restore on-site habitat values to the existing eroded bank condition. The NPW will provide the bank stabilization design and incorporate features to restore habitat conditions of the site to pre-erosion conditions, at minimum.

If the proposed bank stabilization design does not self-mitigate for the loss of existing instream complexity features, the SCVWD will propose to construct one or more of the instream habitat complexity features from the approved list developed above. The instream habitat complexity feature will be located in the same watershed as the SMP bank stabilization project impact. Mitigation may be provided prior to or within a year from the removal of instream habitat complexity features.

3.3 Monitoring

3.3.1 Monitoring Instream Habitat Complexity Features

Sites used for coarse sediment augmentation will be monitored according to the monitoring plan developed per project site and described in the approved design plans.